

University of Louisville

ThinkIR: The University of Louisville's Institutional Repository

Electronic Theses and Dissertations

8-2006

Particle size reduction of phthalocyanine blue pigment.

Robert Ian McDowell 1981-
University of Louisville

Follow this and additional works at: <https://ir.library.louisville.edu/etd>

Recommended Citation

McDowell, Robert Ian 1981-, "Particle size reduction of phthalocyanine blue pigment." (2006). *Electronic Theses and Dissertations*. Paper 946.
<https://doi.org/10.18297/etd/946>

This Master's Thesis is brought to you for free and open access by ThinkIR: The University of Louisville's Institutional Repository. It has been accepted for inclusion in Electronic Theses and Dissertations by an authorized administrator of ThinkIR: The University of Louisville's Institutional Repository. This title appears here courtesy of the author, who has retained all other copyrights. For more information, please contact thinkir@louisville.edu.

PARTICLE SIZE REDUCTION OF PHTHALOCYANINE BLUE PIGMENT

By

Robert Ian McDowell
BScE, University of Louisville, 2005

A Thesis
Submitted to the Faculty of the
University of Louisville
Speed Scientific School
As Partial Fulfillment of the Requirements
For the Professional Degree

MASTER OF ENGINEERING

Department of Chemical Engineering

August 2006

PARTICLE SIZE REDUCTION OF PHTHALOCYANINE BLUE PIGMENT

Submitted by: _____
Robert Ian McDowell

A Thesis Approved on

(Date)

by the Following Reading and Examination Committee:

D.J. Collins, Thesis Director

J.C. Watters

D. J. Hagerty

ACKNOWLEDGEMENTS

First and foremost, I dedicate this thesis in memory of my grandfather, Robert T. McDowell. Although my grandfather battled 10 long and extremely difficult years with Alzheimer's disease, he was still one of the most honorable and carrying human beings I have ever known. I also want to thank my family members including: Robert E. McDowell (father); Carol Stromatt (step mother); Melanie McDowell (mother); Kirsten Merritt (sister); George Meritt (brother-in-law); Heather Sharpensteen (sister); Robbie Sharpensteen (brother-in-law); Caitlyn Stromatt (sister); Kevin McDowell (uncle) and my grandmother (Clara McDowell) for their encouragement and support throughout my entire scholastic career.

In addition, I thank my friends for always keeping my mind off school including: James Fitzstephens; Annie Hong; J.B. Burdette; and Greg Geary for their friendship and support.

Last but not least, I thank my thesis committee for their hard work and dedication in regards to my thesis. Dr. J C. Watters and Dr. D.J. Hagerty both served on my thesis committee and offered important advice and suggestions to improve the quality of my thesis. Extraordinary thanks and appreciation goes to Dr. Dermot J. Collins for his valiant and unyielding support towards both scholastic issues and real life issues.

ABSTRACT

In a printing ink plant, phthalocyanine (Pc) aqueous slurries are produced by grinding the Pc pigment in water using a media mill. Mostly, dispersions of Pc in water are used in heat-set printing inks to make the color phthalo blue. Typically, Pc slurries are 40-50% solids and ground with steel media (spherical beads) to produce a stabilized dispersion with 99.9 percent of all solid particles less than 0.5 microns in size.

Vertical media mills have been the industry norm; however, in producing submicron particle sizes, the efficiency is less than that of newer horizontal media mills that feature high internal flow and multiple pass grinding (Savastano, 2004).

The goal of this experimental study was to determine the optimum operating conditions for a small industrial unit that incorporates newer technology. The first objective was to demonstrate in the laboratory the efficacy of grinding aqueous slurries of Pc using a horizontal peg media mill whose grinding chamber has a small length to width ratio. This was accomplished using a 0.55 L Labstar Zeta mill, producing a satisfactory dispersion. A second objective in the laboratory was to optimize operating conditions (shot loading, agitator speed, and pump speed) in order to minimize the grinding time to produce acceptable product. The optimized conditions were: shot loading level of 85%; agitator speed of 3000 RPM; and pump speed of 200 RPM yielding a run time of 1.33 hours (80 minutes).

The success of this project enabled an industrial chemical company to quickly bring a new 25 L unit on stream to grind and disperse Pc in water. Efficient production of finished ink was accomplished using almost identical operating conditions.

TABLE OF CONTENTS

APPROVAL PAGE.....	iii
ACKNOWLEDGEMENTS.....	iv
ABSTRACT.....	v
TABLE OF CONTENTS.....	vi
LIST OF TABLES.....	vii
LIST OF FIGURES.....	viii
I. INTRODUCTION.....	1
II. LITERATURE REVIEW.....	5
A. Mixing and Dispersions.....	6
B. Grinding/Milling and Dispersants.....	9
C. Pigments.....	12
D. Equipment and Operating Parameters.....	15
E. Particle Size Distribution and Residence Time Distribution.....	17
F. Power Requirements.....	19
III. EXPERIMENTAL.....	24
A. Equipment.....	24
B. Lab Mill Operating Procedures.....	26
IV. RESULTS AND EVALUATION.....	29
A. Preliminary.....	30
B. Optimization.....	36
C. Validation.....	43
D. Epilog.....	49
V. CONCLUSIONS.....	50
VI. RECOMMENDATIONS.....	51
LIST OF REFERENCES.....	52
APPENDIX I. SAMPLE CALCULATIONS.....	54
APPENDIX II. PRELIMINARY DATA.....	59
APPENDIX III. VALIDATION DATA.....	63
VITA.....	67

LIST OF TABLES

Table I - BOND WORK INDEX CHARACTERIZATIONS.....	21
Table II – GUIDE TO EXPERIMENTS PERFORMED.....	29
Table III – RESULTS FOR PRELIMINARY EXPERIMENTAL RUNS.....	31
Table IV – DESIGN OF EXPERIMENT.....	38
Table V –VARIABLES FOR OPTIMIZATION EXPERIMENTAL RUNS.....	38
Table VI – RESULTS OBTAINED IN OPTIMIZATION RUNS FOR THE DESIGN OF EXPERIMENT.....	39
Table VII – STATISTICAL/EXPERIMENTAL RESULTS.....	46
Table VIII – PRELIMINARY DATA.....	60-62
Table IX – VALIDATION DATA.....	64-66

LIST OF FIGURES

Figure 1 – Flowchart of Process to Reduce and Disperse Particles of Pc in Water...	3
Figure 2 – Liquid-Depth-to-Tank-Diameter Ratio.....	6
Figure 3 - Dispersion Blade “Cowles Blade”.....	7
Figure 4a - Step One of Dispersion Process.....	8
Figure 4b - Step Two of Dispersion Process.....	8
Figure 4c - Step Three of Dispersion Process.....	9
Figure 5 - Role of Dispersants.....	12
Figure 6a – Chemical Structure of Pc.....	13
Figure 6b - Starting Materials used to Synthesize Pc.....	14
Figure 7 – Media Mill with Horizontal Grinding Chamber.....	16
Figure 8 – Hydraulic Packing in a Media Mill.....	17
Figure 9 - Continuous Grinding compared to Discrete Grinding.....	20
Figure 10 – LMZ Labstar Zeta Mill.....	24
Figure 11 – Horiba Particle Size Analyzer.....	25
Figure 12 – Specific Energy to Grind Pc Slurry.....	32
Figure 13 – Particle Size Distribution.....	34
Figure 14 – Energy Difference Relative to Particle Size.....	35
Figure 15 – Normal Probability of the Effects Plot.....	41
Figure 16 – Main Effects Plot.....	42
Figure 17 – Shot Loading Effects on Processing Time.....	44
Figure 18 – Agitator Speed Effects on Processing Time.....	45

Figure 19 – Pump Speed Effects on Particle Size..... 47

Figure 20 – Experimental Results Compared to Minitab Predictions.....48

I. INTRODUCTION

Industrial grinding is the process of utilizing a mill to mechanically reduce the size of a solid material to a desired average particle size and distribution. Grinding is subdivided into two primary categories, dry grinding and wet grinding. Specifically, the process of dry grinding involves reducing the particle size of a dry material, often powders and pieces of plastics, by impact and attrition. In contrast, wet grinding reduces the particle size of solids suspended in a liquid. The purpose of wet grinding is to decrease the size of the solid particles to a particle size sufficiently small to remain dispersed in the liquid indefinitely. In wet grinding, the energy input to the suspended particles, also known as the specific energy, results in shearing forces and impact forces causing attrition. Thus, the solids in a liquid carrier are passed through the mill resulting in a dispersion of smaller particles. Of importance in wet grinding, "media mills" or "agitator mills" use grinding media (spherical beads) tailored for both size and material to disperse the solids.

One of the more common organic pigments used for printing ink is phthalocyanine (Pc). An organic pigment is a dry powder often used as a coloring agent or colorant in printing inks. This powder is insoluble in the liquid carrier because of the covalent bonding in the pigment molecule and the polar liquid carrier. Insoluble powders are ideal for printing inks because small particle colloidal suspensions offer long term resistance and stability. Printing inks are composed of an "organic pigment" in a liquid carrier and often require a dispersing agent in order to homogeneously stabilize the pigments. The manufacturing process for printing inks containing Pc begins with slurries of roughly 40% (by weight) Pc solids in water. Likewise, a dispersant (grinding aid to

prevent fine pigment particles from reaggregating) is also used in the formulation of print inks. This Pc/water slurry is passed through a media mill using metal media to grind the Pc solids in the slurry by impacting, shearing, and attrition inside the grinding chamber. The entire process is illustrated in FIGURE 1.

In many chemical companies that manufacture Pc printing inks, vertical disc mills (a form of a media mill) are used to perform the necessary grinding. A disc mill consists of grinding discs or plates and grinding media all contained inside vertically positioned grinding chamber. While Pc slurries can be sufficiently ground to 99.9% less than 0.5 microns using vertical mills, the process is inefficient, resulting in longer grind times. These mills were designed to manufacture dispersions with 99.9% of all particles less than 20 microns (Morgan et al., 2004). A novel approach is to apply the newer horizontal media mill technology towards printing inks, specifically CuPc blue ink.

The goal of this experimental study was to determine the optimum operating conditions for a small industrial unit that incorporates newer technology. The first objective of this study is to demonstrate the efficacy of media grinding on aqueous slurries of CuPc. Using a 0.55 L LMZ Labstar Zeta mill, solid particles in aqueous slurries of Pc are ground to a smaller diameter and a narrow particle size distribution to be sufficiently small to be dispersed in water. The second objective was to optimize the operating conditions in order to minimize necessary grind time. This was accomplished through a systematic adjustment of three operating parameters: shot loading level, agitator speed, and pump speed. The dependant variables are: viscosity; milling temperature; chamber pressure; net power consumption; particle size; and run time. With the optimal range of parameters, the CuPc particles will remain dispersed indefinitely.

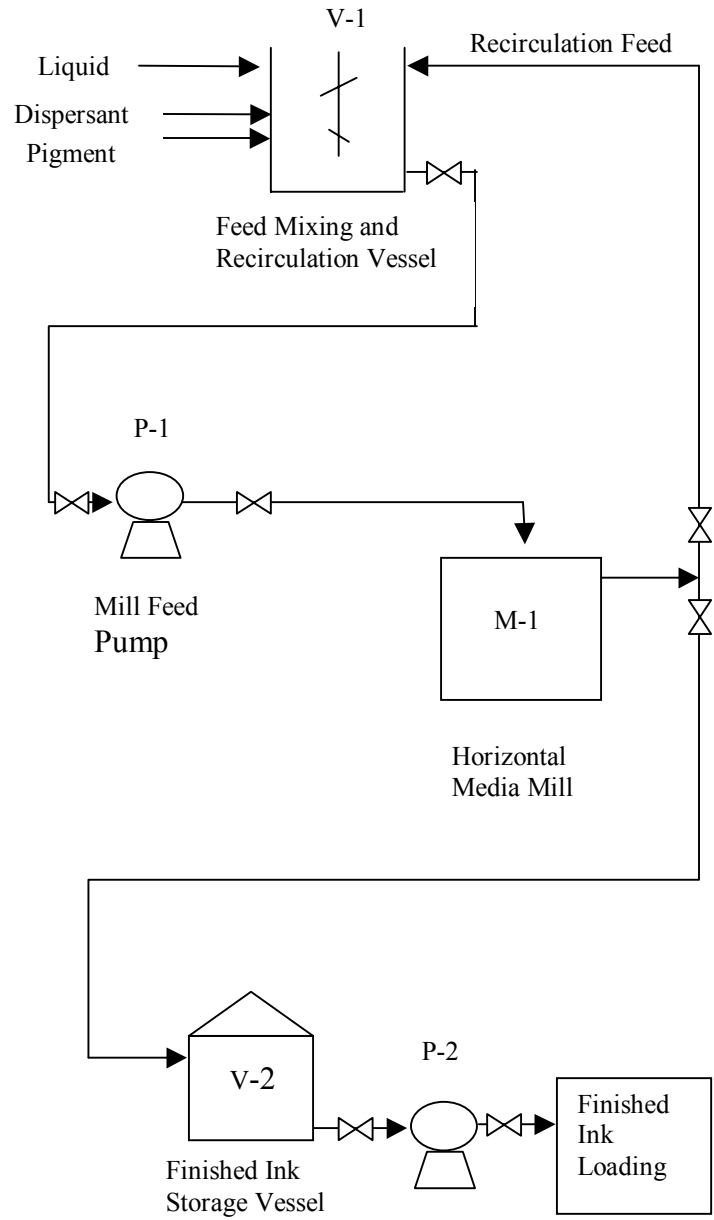

FIGURE 1 - Flowchart of the Process to Reduce and Disperse Particles of Pc in Water

The success of this project enabled an industrial chemical company to efficiently start up production and grind and disperse Pc in water using a 25 L unit. Using operating parameters almost identical to the optimized lab results, this unit was quickly brought on stream, efficiently producing on spec CuPc printing ink.

II. LITERATURE REVIEW

When dispersing solids in liquids, the target is to reduce the size of the solid particles small enough so each particle remains indefinitely suspended in the liquid carrier. Examples of dispersions include ceramics, paints, paper coatings, inks, agrochemicals, pharmaceuticals, cosmetics, detergents and food products.

Fine particle printing ink dispersion is manufactured (FIGURE 1) by a two step process: pigment wetting and stabilization via mixing and dispersing; followed by grinding (Kunjappu, 2001). In the pigment wetting and stabilization step, all of the air is displaced from between the particles of the pigment agglomerates and is replaced by water and dispersing agent. The solid/gaseous interface (pigment/air) is transformed into a solid/liquid interface (pigment/liquid solution) (Laden, 1997). The slurry of pigment, dispersant, and water is mixed in a tank with a dispersing blade breaking apart large particles and dispersing them in the liquid (Laden, 1997). Dispersants stabilize the pigment particles by lowering the mechanical energy needed for grinding (Meyers, 1992). These compounds adsorb to the pigment particles and form a coating of varying composition and thickness (Meyers, 1992). The coating around the pigment particles helps to prevent flocculation by limiting the attraction of negative face charges and positive edge charges.

In the grinding step, the cohesive forces inside the agglomerates have to be overcome; therefore, energy is added to the system (via the mill) producing smaller particles (with larger interface area to the water and dispersant) (Kunjappu, 2001).

A. Mixing and Dispersions

Mixing is a unit operation with the objectives of obtaining homogeneity of a mixture, and of increasing the contact surface in other operations such as dispersing (Sterbacek and Tausk, 1965). Dispersion is the process of breaking agglomerates into small particles by impacting and wetting these particles with media so that the particles remain suspended indefinitely (Friedrich, 2001). High speed mixing with a dispersion blade reduces solids in liquid and homogenously mixes the solids to a suspension. However to produce a colloidal suspension in printing inks, the use of a grinding mill is required to further reduce the size of the solid particles. Mixing behavior is a function of the vessel, impeller, and material being mixed whereas the vessel and impeller are chosen with consideration of geometry, dimensions, and structure (Oldshue, 1984). For blending and solid dispersions, it is well known that the optimum liquid-depth-to-tank diameter ratio Z/T (diagram shown in FIGURE 2) for minimum power usage is 0.6 to 0.7, and that for continuous flow processes the impeller should be placed at the midpoint of the liquid depth (Oldshue, 1984).

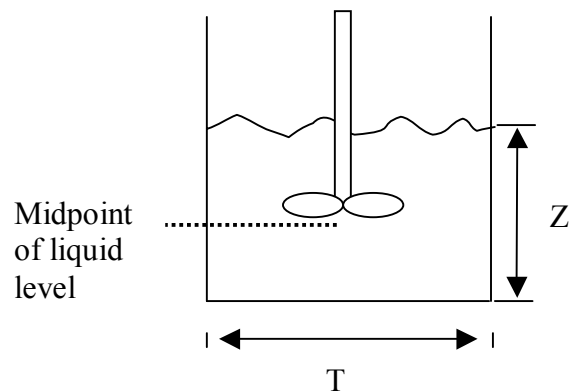

FIGURE 2 - Liquid-Depth-to-Tank Diameter Ratio

There are two impeller types: axial flow and radial flow. An axial flow impeller discharges flow along the axis of the impeller and a radial flow impeller discharges flow along the impeller radius in distinct patterns (Perry and Green, 1999). Examples of impellers used in all types of liquid mixing applications include marine type propellers, hyflo impellers, pitched blade turbines (axial flow), flat blade turbines (radial flow), paddle blade impellers, anchor impellers, helix impellers, and dispersion blades (Oldshue, 1984).

Of importance here is the dispersion blade design because it is the standard for mixing in the paint and ink industry. This blade type was designed to create pumping action that pumps the mixture into the shear zone of the blade. This blade design is the only impeller style that creates enough shear to reduce the particle size of the solids in the liquid (Oldshue, 1984). An example of a dispersion blade is a “Cowles Blade” shown in FIGURE 3. This design is used primarily for ink dispersions.



FIGURE 3 – Dispersion Blade “Cowles Blade” (Indco Mixing Equipment, 2005)

The process of dispersion is a three step process. In the first step, the solid particles hit the dispersion blade and are broken apart (FIGURE 4-a).

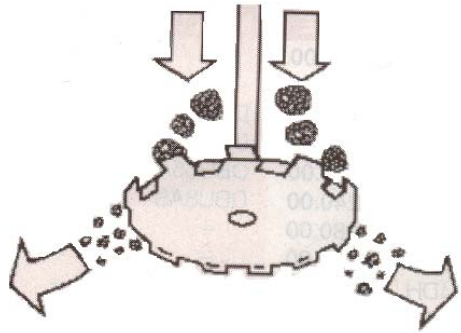

FIGURE 4 (a) – Step One of Dispersion Process (Indco Processing Equipment, 2005)

Next, in the turbulence surrounding the impeller blade, particles hit one another and hit the impeller blade at high speeds, further reducing the solid particle size. The annular area where these collisions occur, beginning at the blade and extending out about two inches, is called the “zone of attrition” (FIGURE 4-b) (Coatings and Inks, 2005).

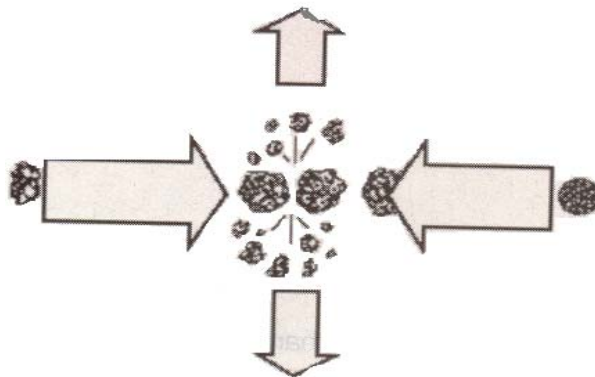

FIGURE 4 (b) – Step Two of Dispersion Process (Indco Processing Equipment, 2005)

Finally the flow pattern established by the impeller blade mixes the broken solid particles moving the material from the zone of attrition to the bulk mixture (FIGURE 4-c).

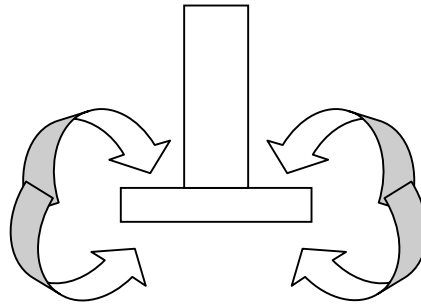

FIGURE 4 (c) – Step Three of Dispersion Process (Indco Processing Equipment, 2005)

Of importance, ink dispersions require more energy and more particle size reduction than is possible with only a dispersing blade, and require the use of a mill.

B. Grinding/Milling and Dispersants

There are several types of dry grinding and wet grinding mills used throughout industry, each designed for a specific application. The processing method (batch, continuous, wet, dry, etc.) and the material processed dictate the exact mill necessary for each application. Mills available in industry include jet mills, bead mills, basket mills, vibratory mills, disc mills, hammer mills, pin mills, rotor-stator mills, and media mills (McCabe et al., 2001). Materials ground in mills include but are not limited to abrasives, adhesives, plastics, cellulose, ceramic pigments, organic pigments, chemicals, cosmetics,

food, graphite, magnetic coatings, motor oil, detergents, metals, and mineral slurries (Netzsch, 1998). An example of a mill used in dry grinding applications is a mechanical impact mill. A mechanical impact mill (also known as a hammer mill) uses rotating hammers or pins and inter-particle collisions to impact airborne dry particles causing the particles to be reduced in diameter (Friedrich, 2001). An example of a dry milling application is milling polycarbonate plastic. An example of a mill used in wet grinding applications is a media mill.

Media mills use grinding media that are specifically selected for both size and material to employ impact and shearing forces. In the small gaps between the media, the impact and shearing forces act on the particles suspended in a liquid reducing the particles in size (Friedrich, 2001). The printing ink industry traditionally uses a form of media mill (vertical disc mill) to produce dispersions of phthalocyanine organic pigment in water. Pc slurries are sufficiently ground in vertical disc mills, but the efficiency is not as high (compared to a horizontal media mill) resulting in longer grind times (Kolb and Ott, 1992). A novel approach is to apply the newer horizontal media mill technology towards printing inks (specifically Pc printing inks). While particle sizes of 20 microns used to be sufficient for inks and paints, high quality products currently must be ground to less than 1 micron (Morgan et al., 2004).

Numerous studies have been conducted on the relationship between grinding media size and desired particle size. To achieve effective grinding, actual ratios of grinding media size to product particle size must be in the range of $10^2 - 10^3$ (Kolb and Ott, 1992). Because the mill is normally filled approximately 70-90% full with media, if the media are too small, much of the free volume in the chamber is filled with media

resulting in less room for product to flow decreasing product flow rates. In turn, the smaller the grinding media, the smaller the particle size of the finished product. In addition, the type of grinding media is very important to the type of product. For example, the grinding and dispersing of hard pigments in inks require steel media for their strength and durability, but the media must also be screened out later with a magnet to prevent contamination. Furthermore, some applications that are extremely temperature sensitive require ceramic grinding media because the ceramic media do not retain the heat generated during the milling cycle. The three main categories are steel, glass, and ceramic media.

In addition, one goal of wet grinding is to reduce the size of the solid particles to a primary or fundamental particle size. Primary particle size is an unaggregated homogeneously solid particle with no void space (McLaughlin, 1999). An aggregate is a clump of fundamental particles that are strongly bonded through a region that is not planar (creating numerous points of contact) and involves some voids (McLaughlin, 1999). An agglomerate or flocculate is a clump of particles in close proximity but not in intimate contact (McLaughlin, 1999). One method to help prevent agglomeration in ink dispersions is the addition of dispersants. Ink dispersions such as phthalocyanine blue ink always require dispersants to prevent agglomeration of particles.

It is common practice to use dispersing agents in order to stabilize pigments homogeneously in liquid media and to obtain storage-stable pigment pastes, paints and lacquers (Weyershausen and Lehmann, 2005). Dispersants adsorb to the pigment particles and form a coating of varying composition and thickness (Weyershausen and Lehmann, 2005). The resulting modified particle surfaces repel each other leading to

stabilization (Weyershausen and Lehmann, 2005). Additionally, the stabilized pigment particles lower the mechanical energy needed for grinding because the ground coated pigment particles will most likely not flocculate back together. Flocculation hampers dispersion, and stabilizing forces are essential to prevent the fine particles of pigment from settling and agglomerating (Weyershausen and Lehmann, 2005). FIGURE 5 illustrates how a dispersant works on solid particles.

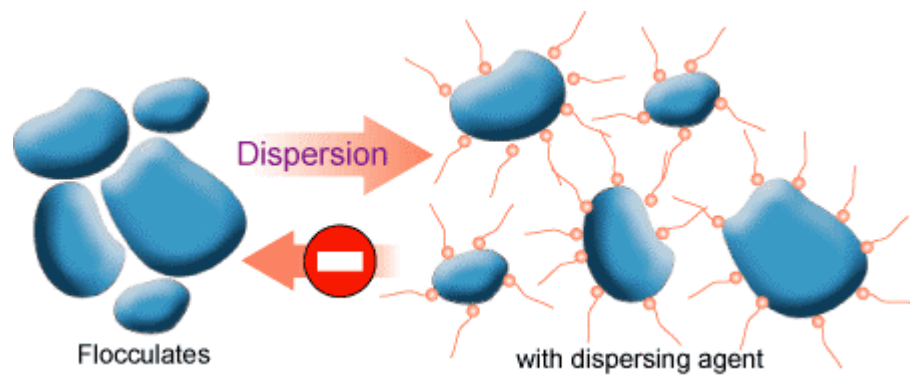

FIGURE 5 – Role of Dispersants (Coatings and Inks, 2005)

The dispersants coat the surfaces of the solid particles causing them to repel each other, thereby helping prevent flocculating, decreasing grinding times, and increasing stability.

C. Pigments

Organic pigments are critical ingredients in the formulation of printing inks and varnishes. Pigment is classified as a colorant, and a colorant is defined as any substance that changes the color of another substance when combined. There are two main types of

colorants in the chemical industry: pigments and dyes. A pigment is not soluble in its vehicle while a dye is soluble (Hao and Iqbal, 1997). An organic pigment is a dry colorant and insoluble (in its liquid carrier) powder that frequently is formed by precipitating a soluble dye with a metallic salt (Hao and Iqbal, 1997).

Of importance here, phthalocyanine (Pc) is an organic pigment that can play host to over seventy different metal ions in its central cavity, resulting in a wide range of applications (McKeown, 1999). Applications of Pc include paints, alkyd resin enamels, printing inks, lacquers, emulsion paints, distempers, rubber, P.V.C and plastics, linoleum, leather cloth, paper and wall paper, tine plate printing, artist's materials, wax compositions, cements, textile printing, heterogeneous catalysts and adsorbents, phthalocyanine photosensitizers in laser cancer therapy, and coatings for read/write CD-ROMs (McKeown, 1999). Pc is an aromatic molecule with four six-member carbon rings with a central binding site for transition metals. The central transition metal is held in place by four inward-facing nitrogen atoms (McKeown, 1963). A diagram of a Pc molecule is shown in FIGURE 6 (a).

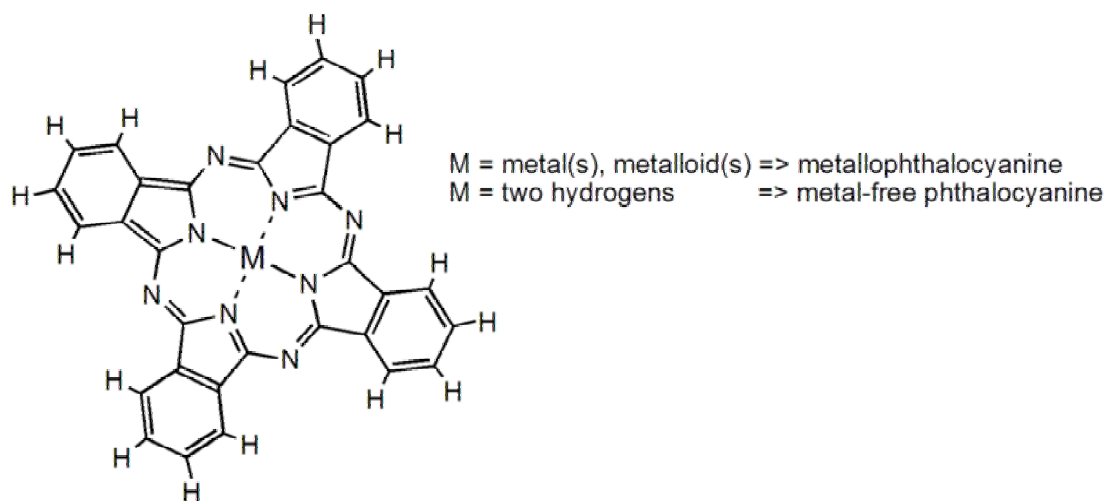

FIGURE 6 (a) – Chemical Structure of Pc (Wikipedia, 2005)

The “M” in FIGURE 6 (a) represents the central binding site. In order for Pc to be used as a blue pigment in water based printing inks, the central binding is often copper (CuPc) (McKeown, 1998). Because of its annular structure, each molecule of phthalocyanine is formed by strong and extremely stable chemical bonds (Engel et al., 1998). Because Pc consists of four identical corners, Pc is often synthesized from molecules that correspond to these corners. Typical molecules used to synthesize Pc are derivatives of phthalic acid: including phthalonitrile; o-cyanobenzamide; phthalanhydride; phthalimide; and diiminoisoindole (McKeown, 1999). FIGURE 6 (b) illustrates several of the starting materials used to synthesize Pc.

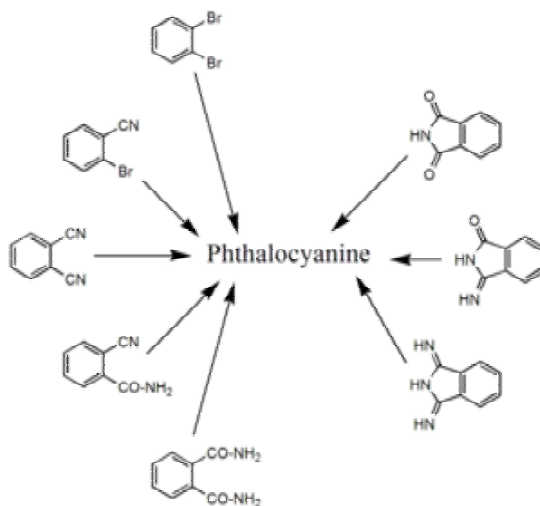

FIGURE 6 (b) – Starting Materials used to Synthesize Pc (Wikipedia, 2005)

Copper phthalocyanine (CuPc) is manufactured in hundreds of tons annually by heating phthalonitrile, or some other related substance derived from phthalic acid, with a copper salt. Pigment manufacturers such as Melidia typically use phthalonitrile in the organic synthesis of CuPc by precipitating the phthalonitrile with copper salt. Other metal Pc

compounds are produced by replacing the copper salt with alternate transition metals such as iron.

D. Equipment and Operating Parameters

Aqueous ink dispersions are milled in media mills (grinding chamber can be either horizontally or vertically arranged). The grinding chamber is usually 70-90% full of grinding media (commonly steel, glass, or wear-resistant ceramic) (Morgan, 2004). An agitator with agitation elements such as pegs or discs provides intensive movement of the grinding media. Horizontal media mills outfitted with grinding pegs are much newer technology compared to disc mills. Traditional ink manufacturers produce ink dispersions with the use of vertical disc mills. A novel approach is to apply horizontal peg media mills to the production of printing ink. The product suspension is continuously pumped through the grinding chamber, grinding and dispersing the suspended solids by impact and shearing forces that are caused by the agitator and media. The product and media are separated by a sieve at the discharge outlet of the mill. A diagram of a horizontal chamber media mill with grinding pegs is shown below in FIGURE 7.

Apart from the machine design, the critical wet grinding and dispersion operating parameters are product temperature, milling and/or residence time in the mill, product flow rate (i.e. pump speed), media size and media loading, and energy (agitator speed).

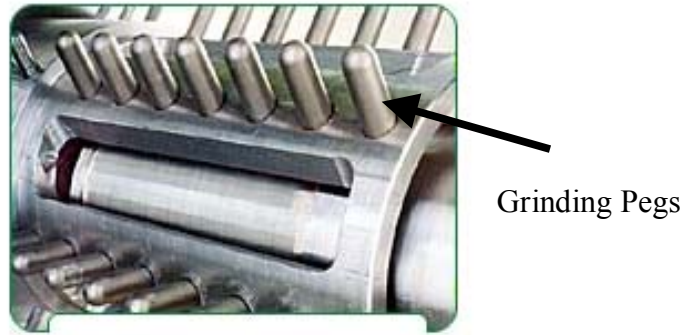

FIGURE 7 – Media Mill with Horizontal Grinding Chamber

(Netzsch, 2006)

Many materials must be kept in a narrow temperature range because of the highly temperature-dependent nature of the product. For example, pigments that are not kept in the desired temperature range will change hue and yield the incorrect shade and color. High product throughput and precise control of media compression result in product temperature control.

Another observable fact related to media mills is hydraulic packing. Hydraulic packing, also referred to in industry as pressure grinding, is the hydraulic compression of media against the discharge end of the milling chamber (McLaughlin, 1999). Hydraulic packing occurs when the material is cycled across the mill at high flow rates and high viscosities. The hydraulic pressure from product flow causes hydraulic packing (McLaughlin, 1999). FIGURE 8 illustrates hydraulic packing. When media are packed in the chamber, the power consumption required is much greater to achieve the same level of grind and dispersion. Also, with the media so condensed into one section, the particle size reduction taking place is much less. Because the media are not able to move as much there are fewer impact forces on the particles.

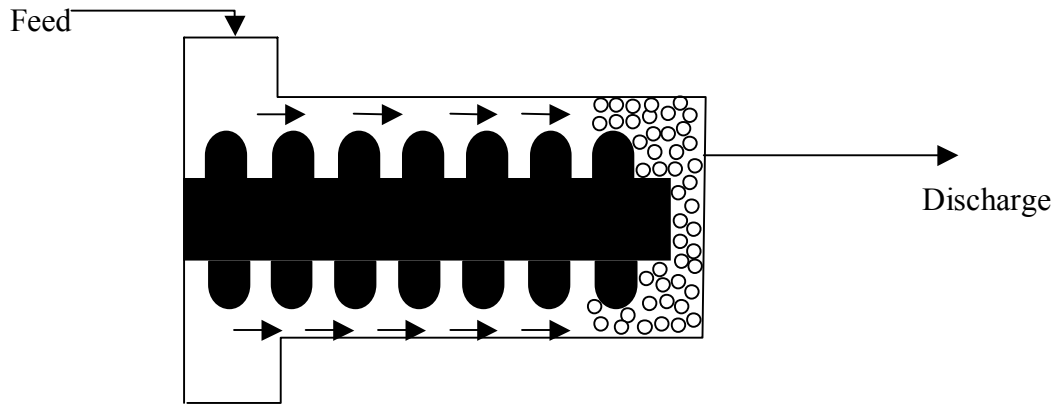

FIGURE 8 – Hydraulic Packing in a Media Mill

The product outlet temperature also increases because the packing covers some of the surface available for cooling (McLaughlin, 1999). Uneven distribution of media in the chamber also will cause a much larger degree of wear on both the media and the mill (McLaughlin, 1999). The main cause of hydraulic packing is the large chamber volume and high length to diameter ratio or the grinding chamber associated with traditional media mills (McLaughlin, 1999). Horizontal peg media mills have a much smaller chamber volume and smaller chamber length to chamber diameter ratio compared to vertical media mills.

E. Particle Size Distribution and Residence Time Distribution

Particle size distribution (PSD) is a particle frequency distribution that shows the percentage of particles found in each size range. A histogram is one of the simplest ways to display a particle size distribution. When dispersing solids in liquids, the desired

distribution is a tight Gaussian distribution. Most of the particles should be centered about the desired final particle size (mean equal to final particle size) and the standard deviation should be close to one. PSD is closely related to the residence time distribution (RTD).

Residence time in the mill is the amount of time the product spends in the milling chamber. While the product is in the milling chamber, it is exposed to work from the system. Because horizontal media mills are equipped with a centrally located agitator, there are few to no dead zones or channeling. Channeling occurs when product continually flows across an undisturbed path through the grinding chamber. The ideal mill would have plug flow; with all the material passing through the machine would travel at the same velocity with uniform grinding. To achieve plug flow, high throughput rates are required (Roelofsen, 1991). For many applications (easy-to-grind materials), material is single-passed through a horizontal media mill. If the material has a low percentage of large particles that will be unacceptable in size, a second pass through the mill will be run to “clean up” these oversize particles (McLaughlin, 1999). On very difficult to grind materials, the general method of decreasing the particle size distribution is to increase the residence time by slowing the feed rate to the mill, usually resulting in a broader particle size distribution. Often, a second or third pass is required to eliminate the small percentage of large particles. It is therefore better to run multiple passes through the mill than to run a single slow pass. High product flow rates result in multiple passes of the product through the chamber and the cumulative residence time will decrease compared to conventional processing methods for horizontal mills (McLaughlin, 1999).

There have been many studies done by mill manufacturers and companies to determine the residence time distribution in a mill (Roelofsen, 1991). FIGURE 9 demonstrates the difference between “high flow with multiple passes” (recirculation) and “slow flow and few passes” (discrete). Although this graph represents limestone dispersed in water, the relationship between discrete and recirculation grinding is the same for every application including ink dispersions (Roelofsen, 1991). The graph illustrates that the recirculation method produces a smaller mean particle size in less time compared to the discrete method. Therefore, the material spends less overall time in the milling chamber due to the high flow rates, but the product also passes through the chamber several more times reducing the unwanted effects of channeling and dead zones. The cumulative residence time decreases and the time necessary to produce the energy input required to obtain a specific particle size also decreases.

Particle size data are reported in the format $d_{99} < \text{“particle size (um)”}$ meaning that 99% of all particles are less than the reported “particle size (um)”. Printing inks such as phthalocyanine dispersions require 99% of all particles less than 0.5 um ($d_{99} < 0.5$).

F. Power Requirements

In dispersions, specific energy is the amount of energy or work necessary to grind a particular solid to a desired particle size. The most common units of specific energy are kW-hr per tonne of slurry. The specific energy required to grind a particular solid to a particular particle size is a fixed value, only dependant on the efficiency of the equipment, processing time, and material being ground (McLaughlin, 1999). Moreover,

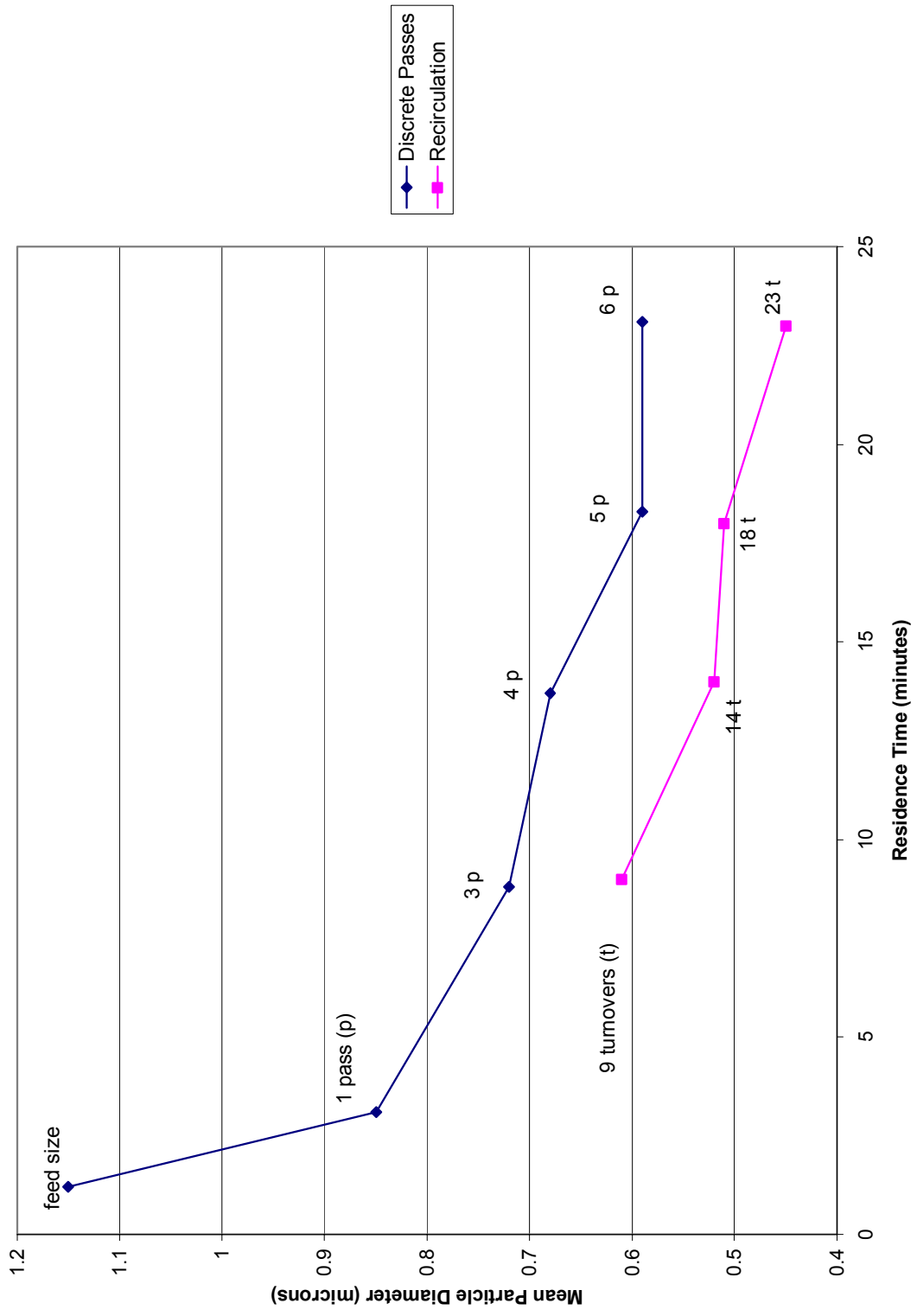

FIGURE 9 - Continuous Grinding compared to Discrete Grinding (Roelofsen, 1991)

the only difference between equipment is the efficiency of the work performed by the equipment. For example, one mill design could require 1000 kW-hr/tonne of slurry to grind an organic pigment in water to 99.9% less than 0.5 microns in size while another mill design could require 1500 kW-hr/tonne of slurry to produce the same results on identical slurry. The theoretical energy necessary to grind a material can be done with either of the following two equations. Bond proposed equation 1 to calculate work which was based on feed size; product size and a rock (pigment) property factor (Bond, 1952). The work index (W_i) is based on the hardness of the pigment (Table I).

$$W = 10 * W_i \left(\frac{1}{P^{\frac{1}{2}}} - \frac{1}{F^{\frac{1}{2}}} \right) \quad 1$$

Where: W is the work input $\left(\frac{\text{kW-hr}}{\text{tonne}_{\text{solids}}} \right)$;

W_i is the work index for pigment type $\left(\frac{\text{kW-hr}}{\text{ton}_{\text{solids}}} \right)$;

P is 80% (d80) product size (microns); and

F is 80% (d80) feed size (microns).

TABLE I – BOND WORK INDEX CHARACTERIZATIONS

Property	Soft	Medium	Hard	Very Hard
Bond W_i (kW-hr/tonne)	7-9	9-14	14-20	>20

Pc is classified as a very hard pigment and would therefore receive a work index of greater than 20 (McKeown, 1999). “Greater than 20” is not a precise number, but a rough estimate of the work can be calculated.

As well, the grinding energy can be calculated using the transmitted energy grinding theory equations developed by Kolb and Ott (1992):

$$BI_m = d_m^3 * \rho_m * v_t^2 \quad 2 (a)$$

$$BZ_m = n * t * \left(\frac{x}{d_m} \right)^2 \quad 2 (b)$$

$$E_{SP} = \kappa * BI_m * BZ_m \quad 2 (c)$$

Where:

- κ is the proportionality constant and is unknown;
- BI_m is the intensity of the contacts (kW-hr);
- BZ_m is the number of contacts;
- E_{SP} is the transmitted grinding energy (kW-hr);
- d_m is the diameter of the media (mm);
- ρ_m is the density of the media (kg/dm³);
- v_t is the circumferential speed of agitator (m/sec);
- n is the number of revolutions of the agitator (RPM);
- t is the residence time (hr); and
- x is the characteristic particle size of solids to be ground (μ m).

This theory states that the “transmitted grinding energy is proportional to the number of contacts and the intensity of contacts.” It is somewhat useful in predicting an approximate transmitted energy per piece of media because a proportionality constant can be suggested. E_{sp} can be reported in units of kW-hr/tonne by simply dividing the kW-hr value by the batch size in tonnes. This equation is not useful here because there are no published values of the parameter κ . Perhaps the data from this study may be useful in helping to determine a κ value in the future. A theoretical specific energy can be calculated from equation 1. The theoretical energy values can be compared to actual results obtained on horizontal media mills.

The actual specific energy (SE) can be calculated:

$$SE = \frac{NPC(RT_2 - RT_1)}{BS} \quad 3$$

Where: NPC = net power consumption (kW)

RT = Residence time (hr)

BS = Batch Size (tonne)

Sample calculations are given in Appendix I.

III. EXPERIMENTAL

A. Equipment

The operating device used during the experimentation on the aqueous dispersions of Pc was the LMZ Labstar Zeta mill. The LMZ Labstar Zeta mill also utilizes a positive displacement pump and mini post mixer. In addition, the LMZ Labstar Zeta mill is equipped with a digital control system (DCS) called LABDAT©. LABDAT© is a software package developed by NETZSCH-Feinmahltechnik that documents and analyses development and quality assurance tests. Power input of the agitator shaft, agitator shaft speed, pump speed, grinding chamber pressure, product inlet and outlet temperatures, and cooling water inlet and outlet temperatures are all monitored and recorded. The LMZ Labstar Zeta mill is shown below in FIGURE 10.



FIGURE 10 –LMZ Labstar Zeta Mill (Netzsch Inc, 2006)

The equipment used for mixing the Pc in order to prepare the feed for the milling stage was a mini pre-mixer shown in FIGURE 10. The feed to the LMZ Labstar Zeta

Mill consisted of a desired amount of Pc mixed in a tank with a desired amount of water and surfactant using the pre-mixer. Once mixed, the feed was pumped, using the positive displacement pump, from the tank to the LMZ Zeta Mill. The DCS then was programmed to maintain a constant flow rate and constant energy input. Once the feed was pumped into the grinding chamber, the solids suspended in the liquid solution of Pc were treated with impact and shear forces due to the grinding media and agitator shaft. The interior of the grinding chamber is shown in FIGURE 7. Energy is available to work on the suspended solids because of the rotation of the agitator in the milling chamber. As the feed is continuously pumped through the grinding chamber, the shear and impact forces reduce the overall particle size of the solids. The DCS also records the inlet and exit grinding chamber parameters; i.e. flow rate temperature and pressure, etc.

The DCS is shown in FIGURE 10. The digital control panel controls the flow rates, temperatures, and pressures at the entrance and exit of the grinding chamber. The particle size of the solid particles and the particle size distribution was analyzed with a Horiba light scattering particle size analyzer shown in FIGURE 11.



FIGURE 11 – Horiba Particle Size Analyzer (Horiba, 2006)

B. Lab Mill Operating Procedures

1. Fill the mill 70-90% full of 0.25 mm steel shot.
2. Check the formula specification for % solids.
3. Add desired amount of water to the mixing vessel.
4. Add desired amount of dispersant to the mixing vessel.
5. Add desired amount of pigment to the mixing vessel.
6. Insert the mixer into the mixing vessel and set the mixer at desired speed.
7. Place the mixer splash guard around the agitator and on top of the vessel.
8. Turn on the mixer power switch and mix the slurry until it appears to be homogeneous.
9. While the feed is being premixed, turn on the cooling water supply to the chamber of the LMZ labstar Zeta mill. This may be accomplished by rotating the chill water supply valve to an open position.
10. Once the slurry is homogeneous, remove the mixer from the top of the vessel.
11. Open the mixing vessel outlet and inlet valves. This allows for material exiting the grinding chamber to be pumped back into the mixing chamber and continuously processed.
12. Turn on the power switch to the positive displacement pump and set pump to desired RPM using the DCS.
13. Turn on the power switch to the agitator motor and set the motor to desired RPM.
14. Program the DCS to announce alarm if temperatures reach within 10 degrees of customer specifications.

15. If the high temperature warning alarm sounds, adjust the water valve to allow more flow of cooling water.
16. If the Pc temperature continues to rise with cooling water open fully, the energy input must be decreased by slowing the agitator motor in order to decrease the heat input in the system.
17. If temperature continues to rise, shut mill down until material inside chamber has cooled to room temperature.
18. If the pressure in the mill exceeds the pressure limit on the mechanical seal (5.5 Bar), the mill motor will shut down. Therefore, limit the amount of chamber pressure by limiting the amount of shot loading or decreasing the pump speed.
19. Allow the Pc slurry to run continuously for desired amount of time, monitoring the parameters every fifteen minutes.
20. Tank a sample of the material every 15 minutes for analyzing.
21. Once the Pc has been processed for the desired amount of time, close the mixing vessel outlet valve.
22. Shut the agitator motor off.
23. Pump all finished material back into the mixing vessel.
24. Once all the ink is removed from the LMZ Labstar Zeta mill, shut off the power to the positive displacement pump.
25. Close the mixing vessel inlet valve.
26. Pour all the finished ink from the mixing vessel into a separate storage vessel.
27. Add approximately 5 kilograms of wash water into the mixing vessel.
28. Reopen the mixing vessel exit and inlet valves.

29. Turn on the power to the positive displacement pump to 50 RPM.
30. Turn on the power to the agitator motor to 500 RPM.
31. Allow wash water to circulate through the mill and mixing vessel for fifteen minutes.
32. Once the wash water has circulated for fifteen minutes, shut down the mill agitator motor.
33. Close mixing vessel outlet valve and pump all wash water into the mixing vessel.
34. After all wash water is pumped back into the mixing vessel, close the mixing vessel inlet valve and turn off the positive displacement pump.
35. Pour all the wash water into a separate vessel for proper disposal.
36. Analyze the collected material samples for viscosity and particle size.

IV. RESULTS AND EVALUATION

The first objective was to demonstrate the efficacy of media grinding to produce an aqueous slurry of phthalocyanine in the laboratory. Then after this was accomplished, an optimization set of experimental runs was performed. These optimization runs followed the rules for factorial design. Finally, validation experimental runs were performed on these results. TABLE II shows the number of experiments performed per set. All experiments were performed on a 0.55 L LMZ Labstar Zeta media mill.

TABLE II - GUIDE TO EXPERIMENTS PERFORMED

Experimental Set	Run Numbers
Preliminary	1 - 3
Optimization	4 - 11
Validation	12 - 28

Steel shot with a diameter of 0.25 mm was used for all experimental runs. Shot size is primarily determined by two criteria: (1) beginning average particle size of solids and (2) desired average particle size of finished slurry. The beginning average particle size of the phthalocyanine pigment is around 4 micron and the desired particle size of the milled slurry is 0.5 microns. Industry experience shows 0.25 mm media are desirable for 4 um particle sizes (Savastano, 2004). The ratio of grinding media size to product particle size was 500 and within the desired range of $10^2 - 10^3$ (Kolb, 1992). Steel was chosen as the grinding medium type because it is durable and suitable for use with hard pigments such as Pc. The percent solids of each experimental run was set at 44%, per customer specification. The effect of shot size was not examined in this investigation.

The three operating parameters varied throughout experimentation were shot loading level, agitator speed, and pump speed. The dependant variables associated with varying the operating parameters are: viscosity; milling temperature; chamber pressure; net power consumption; particle size; and run time. The viscosity and temperature must stay in a range, per customer specification, of 170 -225 cp and less than 75°C respectively.

The power consumption and run time were used to calculate the specific energy. The specific energy is the amount of energy or work necessary to grind CuPc down to 0.5 microns. It is well established in industrial practice that particle size distribution can be related to specific energy, meaning to achieve a desired distribution, the same amount of energy is always required (McLaughlin, 1999).

A. Preliminary

The preliminary experimental runs were important for two reasons. First, these runs accomplished objective one: authenticate a media mill's ability to consistently grind aqueous slurries of phthalocyanine to $d_{99.9} < 0.5$ microns in size. Also, data from these runs were used to determine the amount of energy necessary to produce aqueous slurries of phthalocyanine. The amount of energy input per unit of mass (specific energy) is the most important quantity calculated in this set of runs.

Initially there were scouting runs to achieve “on spec” product that included considerable improvisation and modification. These are not reported here. Then for the reported experimental runs, samples were obtained after 15, 30, 60, 90, 100, 120, and 150 minutes of processing time. The first objective was to demonstrate the feasibility of media grinding, and for that reason, run numbers 2 and 3 were replicas

of the first run. Run numbers 1, 2, and 3 were intended to show that a horizontal media mill has the ability to grind Pc ink slurries and to establish that the results are repeatable. All preliminary experimental data collected are in Appendix II; only significant results are given in TABLE III.

TABLE III - RESULTS FOR PRELIMINARY EXPERIMENTAL RUNS

Run Number	d99.9 < (X) microns	Run Time (min)	Specific Energy (Kw-hr/tonne)	v (CP)	T (°C)	P (bar)
1	0.448	100	603	200	54	0.5
2	0.452	100	603	200	55	0.5
3	0.456	100	603	200	54	0.5

The particle size specification for runs numbers 1, 2, and 3 (analyzed using a Horiba particle size analyzer) was $d_{99.9} < 0.5 \mu\text{m}$. The complete grinding profile though 150 minutes is shown in FIGURE 12. As can be seen, the slurry required 100 minutes of mill time to achieve the desired specification. The specific energy is calculated by dividing the net power consumption by the batch size and multiplying by the recirculation time (Sample Calculations Appendix I). The results clearly show that an energy input of approximately 600 kW-hr/ton of slurry is needed to attain a particle size that is $d_{99.9}$ less than about 0.5 microns. This specific energy is the amount of energy required to grind the Pc particles from a beginning particle size of 4 μm to 99.9% less than 0.5 μm in a LMZ Labstar Zeta media mill. The viscosity and temperature specifications were within the desired range of 170 -225 cp and less than 75°C respectively. The chamber pressure was below the mill working conditions (less than 5 bar gauge). These results prove that a media mill can be used to consistently grind Pc in water. The mill shot loading level, agitator speed, and pump speed can be

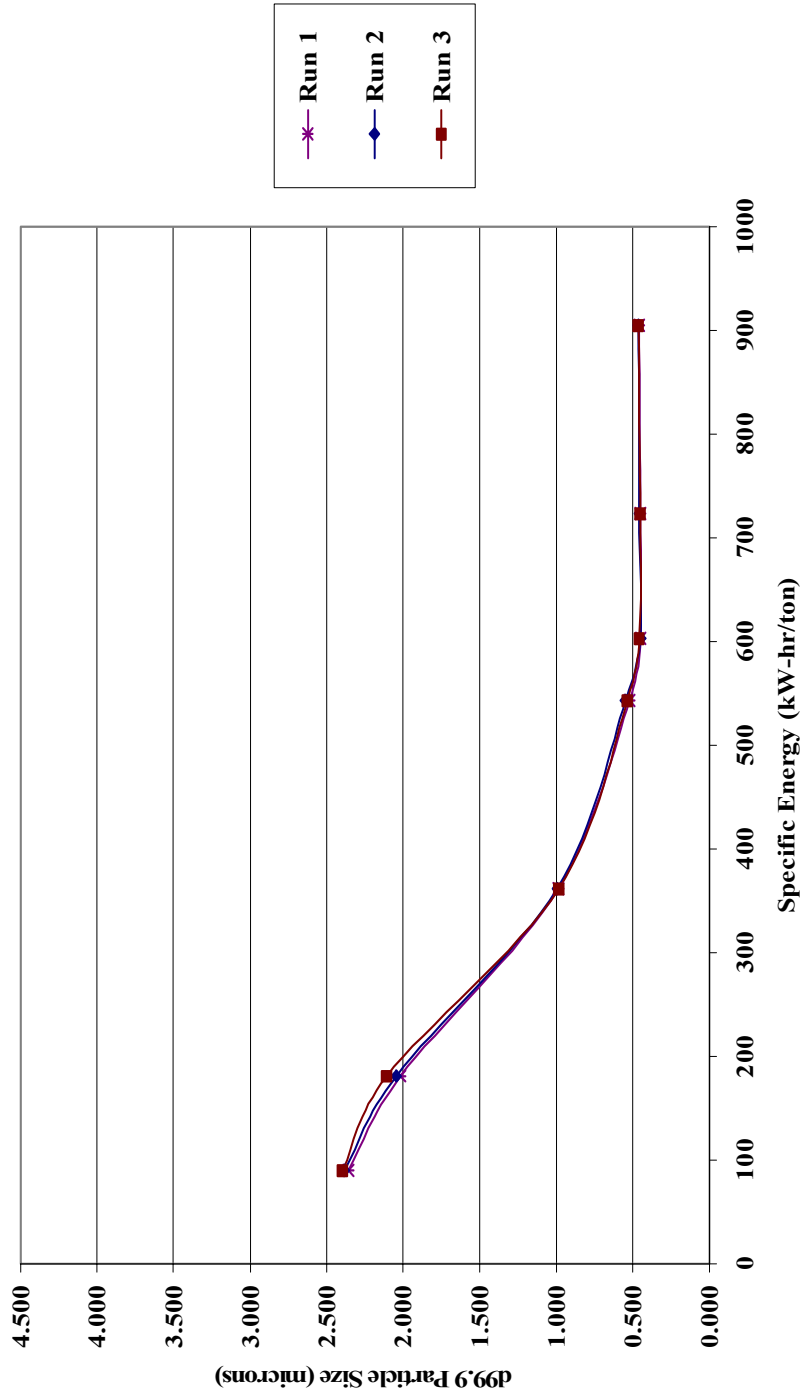

Figure 12 – Specific Energy to Grind Pc Slurry

optimized in order to achieve a minimized time needed to obtain the necessary energy input of roughly 600 kW-hr/tonne of slurry.

The preliminary trials also verified that the desired particle size can be consistently achieved from run to run, FIGURE 12. It is important to note the particle size appears to begin to plateau around 600 kW-hr/tonne. This most likely occurs because there is an over grind phenomenon associated with media mills. That is, when solid particles are ground to extremely small sizes, flocculation and agglomeration tend to be more prevalent. Myers (1992) reports instances where some investigators found particle size to actually increase when too much energy is applied. There is nothing to be gained from increased energy input.

Variation in particle size distribution with time is shown in FIGURE 13 - a logarithmic curve illustrating the relationship between time, specific energy, particle size, and percent finer. The curve shows that the smaller the particle size and/or the higher % finer, more milling time and specific energy is necessary. Initially, the feed sample had only about 5% finer than 0.5 microns. The family of curves showed a similar pattern and each curve shifted to the right with increased grind time and specific energy. It can be seen in FIGURE 13 that the particle size does actually decrease after 100 minutes. That is, the movement of this family of curves to the right reflects a reduction in average particle size. The d_{99.9} (or 99.9% finer) less than 0.5 microns does not change after 100 minutes because all material meets specification. This gives the appearance of a particle size plateau in figure 12.

FIGURE 14 exemplifies the vast amount of energy difference between particle size specifications of 90% and 99.9%. From the graph, the d₉₀ (90%) dataset line passed below the 0.5 microns size around 120 kW-hr/tonne. Also from the graph, the d_{99.9} (99.9%) dataset line passed below the 0.5 microns size at about 600 kW-

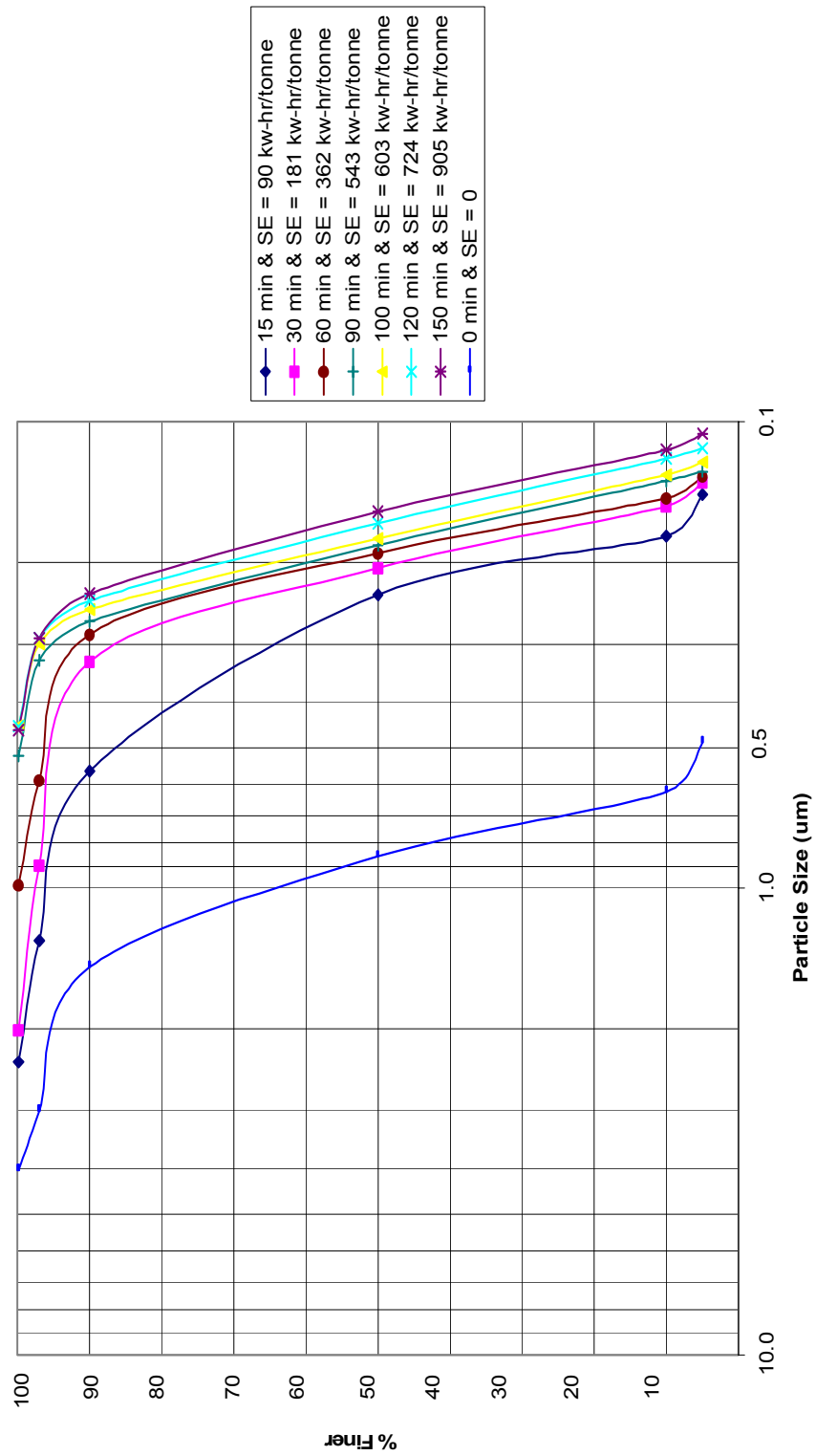

FIGURE 13 - Particle Size Distribution

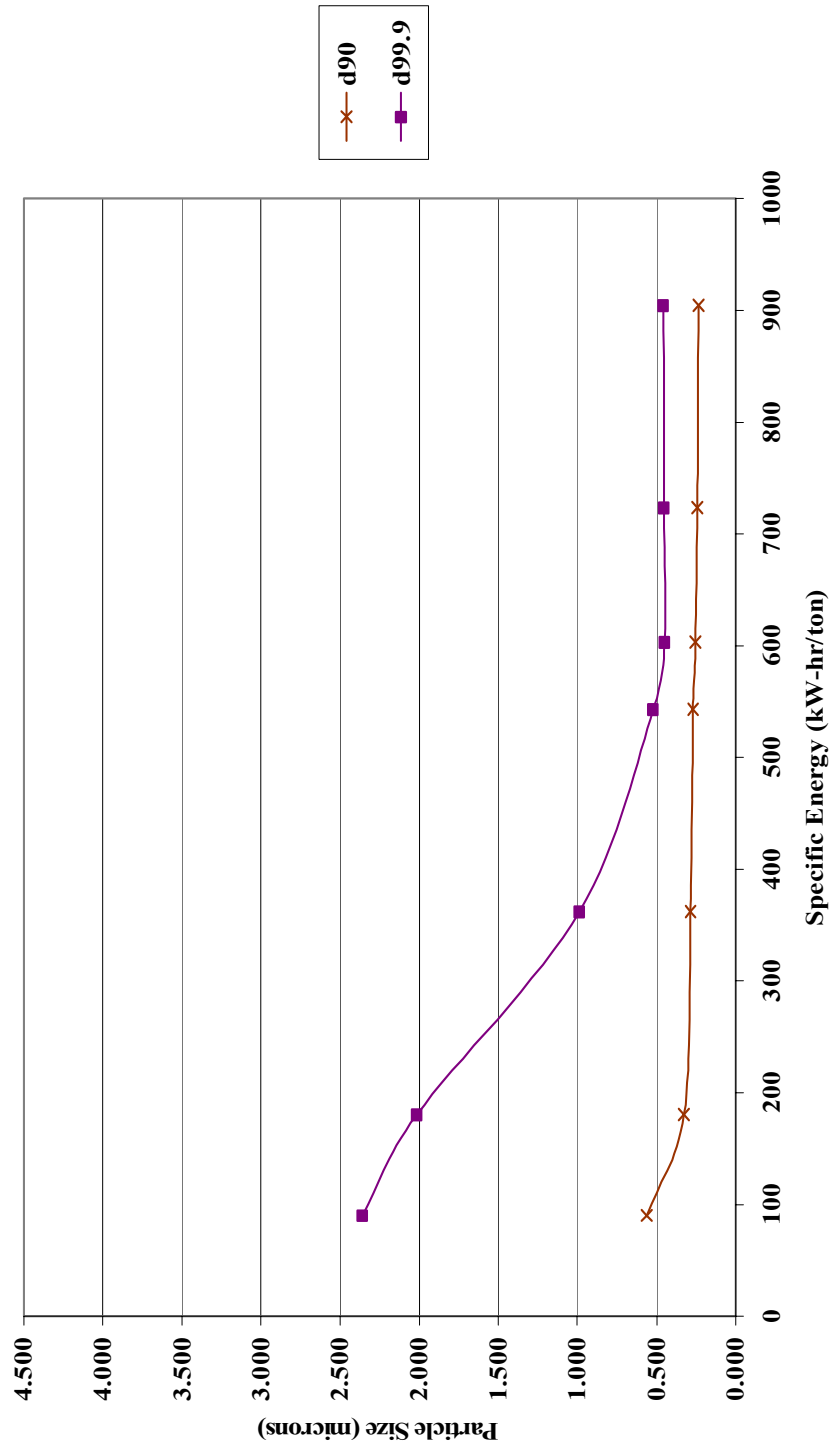

Figure 14 – Energy Differences Relative to Particle Size

hr/tonne. A d99.9 would have a tighter PSD compared to a d90. The energy difference demonstrates the difficulty and extra work required to obtain a tighter particle size specification.

The experimental energy requirements were compared with a literature model, specifically the Bond Equation, which is usually applied to grinding and pulverizing rock. A work index factor is arbitrary because the relationship between CuPc and rock is unknown. However, if a work index factor of 21 - 22 is used from Table I (Pc is classified as a very hard pigment - McKeown, 1998), then Bond's equation (1) gave a result in the range of 599 - 627 kW-hr/tonne of slurry. The experimental specific energy was about 600 kW-hr/tonne of slurry. Therefore, the Bond equation agreed with the experimental value within 4%.

The preliminary trials were successful in showing the ability of a media mill to successfully grind aqueous phthalocyanine slurries and in determining the necessary energy inputs. Regardless of what factors or conditions are changed throughout the milling, the correct amount of energy must be put into the system in order to achieve the desired particle size (McLaughlin, 1999). With a known energy input of approximately 600 kW-hr/tonne of slurry necessary to attain a desired particle size of $d_{99.9} < 0.5 \mu\text{m}$, optimization trials were performed to maximize the efficiency of the LMZ Labstar Zeta media mill. Finished product from all runs at 600 kW-hr/tonne was analyzed for particle size. Every sample passed the d99.9 specification.

B. Optimization

A traditional approach to optimization is to perform a factorial design of experiment (DOE). A factorial DOE is a structured, organized method for

determining the relationship between factors (Xs) affecting a process and the output of that process (Y). Then using statistical analysis, results from this DOE can be used to predict optimal process performance parameters.

The five independent variables are shot size, percent solids, shot loading level, agitator speed, and pump speed. It should be noted that residence time is also a vital independent variable affecting run time; however the residence time is directly controlled by the pump speed. The shot size was maintained at 0.25 mm as in the preliminary experiments. The percent solids were maintained at 44% solids as in the preliminary experiments. Therefore, the three independent variables or process parameters are shot loading level, agitator speed, and pump speed. The results of the optimization experiments were analyzed to find a combination of process parameters to minimize the required grinding time. Minitab is a statistical software package which provides quick, easy, and reliable data analysis.

The DOE was a two-level full factorial design using three factors. Two-level means each factor includes one high (1) and one low (-1) value. Full factorial indicates every combination of the three factors is taken into account ($2^3 = 8$) requiring 8 experiments. It should be noted that while Minitab is not mandatory it does offer a clear approach to the experiments as well as offering statistical analysis on the results obtained. Table IV displays the DOE generated using Minitab. The last column (Run Time necessary to attain 603 kW-hr/tonne Specific Energy (min)) is left blank because the experimental result will later be entered into this column. The response variable is run time (in minutes) necessary to attain the required specific energy (603 kW-hr/tonne). The response variable is the dependant variable that is either maximized or minimized (in this case minimized). All eight experiments were performed to produce response variable data that could be analyzed using Minitab.

TABLE IV – DESIGN OF EXPERIMENT

Experiment #	Shot Loading (%)	Agitator Speed (RPM)	Pump Speed (RPM)	Run Time necessary to attain 603 kW-hr/tonne Specific Energy (min)
4	1	1	1	
5	1	-1	1	
6	-1	1	-1	
7	-1	1	1	
8	1	1	-1	
9	-1	-1	-1	
10	1	-1	-1	
11	-1	-1	1	

Table V indicates the dependant factors with high (1) and low (-1) settings and the response variable.

TABLE V - VARIABLES FOR OPTIMIZATION EXPERIMENTAL RUNS

Independent Variables		Response Variable
Media Size	0.25 mm	Run Time (min)
Percent Solids	44% (specified by formulation)	
Shot Load	1 = High Value (90%)	
	-1 = Low Value (70%)	
Agitator Speed	1 = High Value (3000 RPM)	
	-1 = Low Value (2500 RPM)	
Pump Speed	1 = High Value (200 RPM)	
	-1 = Low Value (150 RPM)	

The results from the DOE eight experiments performed are in Table VI. Each batch was processed until a calculated specific energy (SE) of 603 kW-hr/tonne was achieved. Once the desired SE was reached, a sample of each batch was analyzed for

temperature, pressure, viscosity, and particle size. Temperature and viscosity met customer specifications over the entire range of factors during the eight experiments. The temperature increased most with the 90% shot loading, but was still acceptable. Pressure (mechanical seal specified) was under the working limits of the mill no matter what factors changed during the experiments. The three conditions resulting in the shortest run time were shot loading = 90%, agitator speed = 3000 RPM, and pump speed = 200 RPM. The values of 87, 88 and 90 minutes are not significantly different from each other. This shows that for these experiments the predominant factor affecting run time is shot loading.

TABLE VI – RESULTS OBTAINED IN OPTIMIZATION RUNS FOR THE DESIGN OF EXPERIMENT

Shot Loading (%)	Agitator Speed (RPM)	Pump Speed (RPM)	Run Time necessary to attain 603 kW-hr/tonne Specific Energy (min)	Temperature (^o C)	Chamber Pressure (bar)	Viscosity (cp)
90	3000	200	87	62	2.2	200
90	2500	200	90	60	1.8	200
70	3000	150	132	54	0.6	200
70	3000	200	132	55	0.7	200
90	3000	150	88	62	2.1	200
70	2500	150	143	55	0.6	200
90	2500	150	92	61	1.8	200
70	2500	200	143	54	0.6	200

A production goal is to minimize run time in order to maximize throughput. Minimizing run time requires adjusting pump speed, agitator speed, and shot loading. Faster pump speed means material passes through the mill faster, but the faster the pump speed the less residence time material has in the grinding chamber. However, the temperature and pressure can limit how fast the pump can be set. Faster pump speeds also increase chamber pressure in the mill. Likewise, increased shot loading

and increased agitator speeds also increased chamber pressure. Chamber pressure must be kept under 5 bar gauge; otherwise the mill will shut down. The mechanical seal on the mill can not safely operate above 5.5 bar. The mechanical seal allows the agitator to turn freely inside the chamber without material passing through the seal and destroying the bearings. Results from the preliminary experiments show the maximum pump speed of 200 RPM did not come close to exceeding the pressure restriction on the mill. Nevertheless, the maximum pump speed combined with the increased shot loading and agitator speeds could cause the chamber pressure to exceed the limit. The maximum pump speed causes the material to have less residence time and less time to increase in temperature due to energy input.

Faster agitator speed means more energy input into the system per unit of time. Faster agitator speeds also increase the temperature of the product and chamber pressure.

Higher shot loading allows for more media to perform particle size reduction. However, more media also increases chamber pressure and decreases void volume. An increase in media also increases the work necessary to turn the agitator resulting in added temperature to the product. Higher media loading reduces material flowing space and could cause the mill to shut down on high chamber pressure or high product temperature. All in all, each factor must be optimized relative to the others in order to minimize the run time.

FIGURE 15 shows the normal probability of effects plot generated by Minitab using results from the optimization experiments. In the normal probability plot of the effects, points that do not fall near the fitted line usually signal important effects. Important effects are larger on the y-axis (%) and farther from the fitted line than unimportant effects. Unimportant effects tend to be smaller and centered about zero.

This plot distinguishes the most important factors. Clearly, only one out of the eight factorial combinations was significant (Shot Loading). Only the significant factors are labeled on the Normal Probability of the Effects Plot. Thus (shot loading) was the most important factor altering the run time.

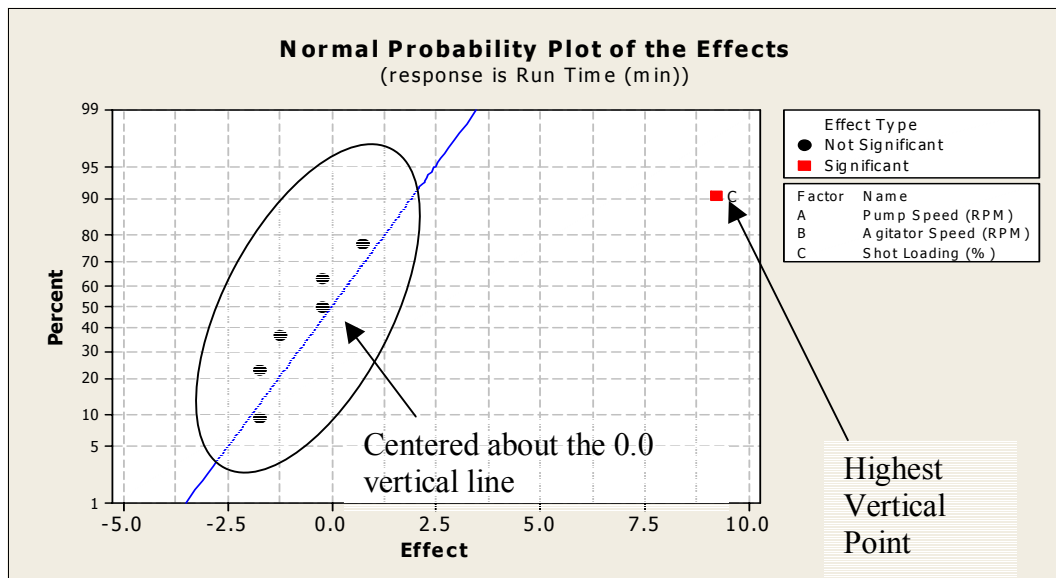

FIGURE 15 – Normal Probability of the Effects Plot

Figure 16 displays the main effects plot. This plot is a “main effects” plot to compare the magnitude of the interactions between each of the three factors. The two points in each of the three main effects plots are the means of the response variable at the various levels of each factor, with a reference line drawn at the grand mean of the response data. The line with the largest slope has more impact on the response variable (run time). Thus, shot loading is the most important followed by agitator speed then by pump speed. Also, pump speed was insignificant compared to agitator speed and shot loading.

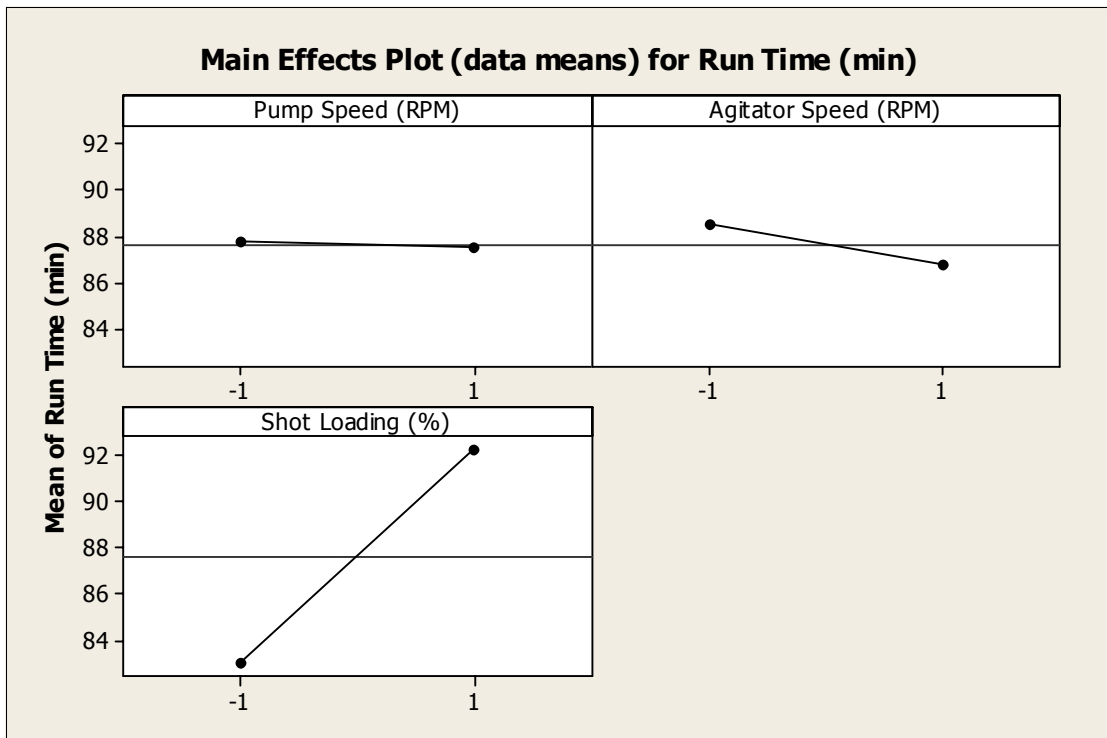

FIGURE 16 – Main Effects Plot

The normal probability plots and main effects plots are to be used together when determining the most important factors. Although, in this case, the normal probability of the effects plot was sufficient to distinguish the most important factor, the main effects plot was generated just to illustrate the order of significance of each of the three separate factors.

It appears that the shot loading is the key factor that masks all other factors. This discovery was somewhat to be expected because a greater amount of media in the mill allowed more opportunity of collisions and particle size reduction, however an excess of media hinders grinding. In many optimization experiments, only one variable is changed at a time requiring several experiments. Using a DOE, more than one variable is changed in each run, decreasing the overall amount of experiments

necessary. The results of the DOE show the minimized run time occurring at a shot loading level of 90%, agitator speed of 3000 RPM, and pump speed of 200 RPM.

C. Validation

Validation experiments were performed on the lab mill to authenticate and adjust if necessary the results of the optimization experiments. These are a starting point to begin the validation experiments. Seventeen validation experiments were performed and the experimental data are in Appendix III. These experiments were performed over a range of adjusted factors (shot loading level, agitator speed, and pump speed). Data were recorded on how long each experiment ran until a specific energy value of approximately 600 kW-hr/ tonne of slurry was reached. FIGURE 17 (runs 12 – 20) illustrates the affect of shot loading on run time. First, the effect of shot loading can be seen. When the shot loading decreased from 95% to 85% the net power consumption increased, resulting in decreasing times necessary to reach 600 kW-hr/tonne of slurry. When media loading was less than 85%, the time necessary to reach the 600 kW-hr/tonne increased. This increase in time was because the net power consumption began to decrease and the mill became less efficient. At higher shot loadings, it was difficult to operate at 3000 RPM, and the pump ran slightly slower. Therefore, the optimized percent shot loading is 85.

During runs 21 – 25, the agitator speed was decreased in order to verify if the recirculation time would increase as expected. FIGURE 18 illustrates the affect of agitator speed on run time. After the agitator speed dropped below 3000 RPM (the

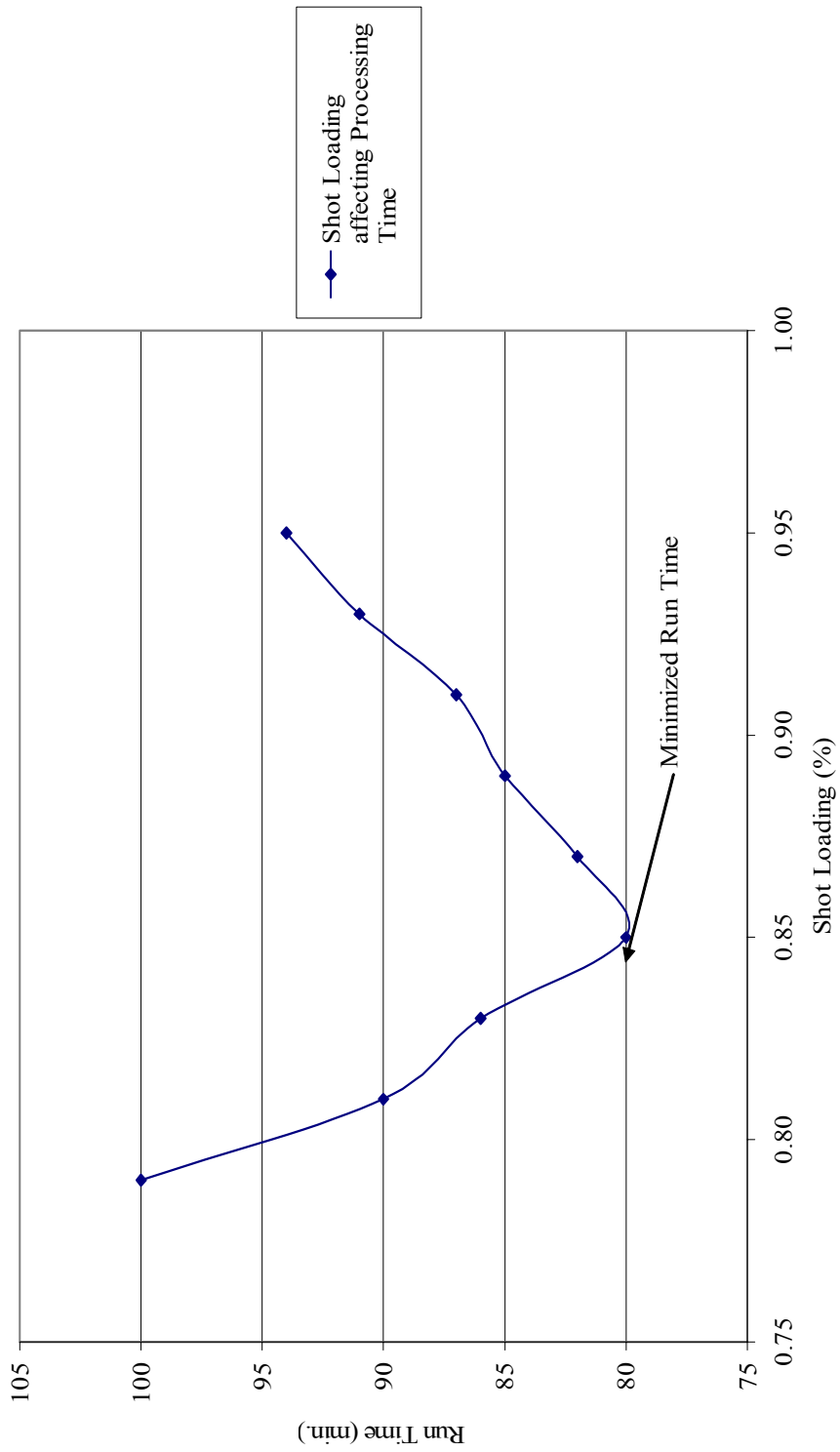

FIGURE 17 - Shot Loading Effects on Processing Time

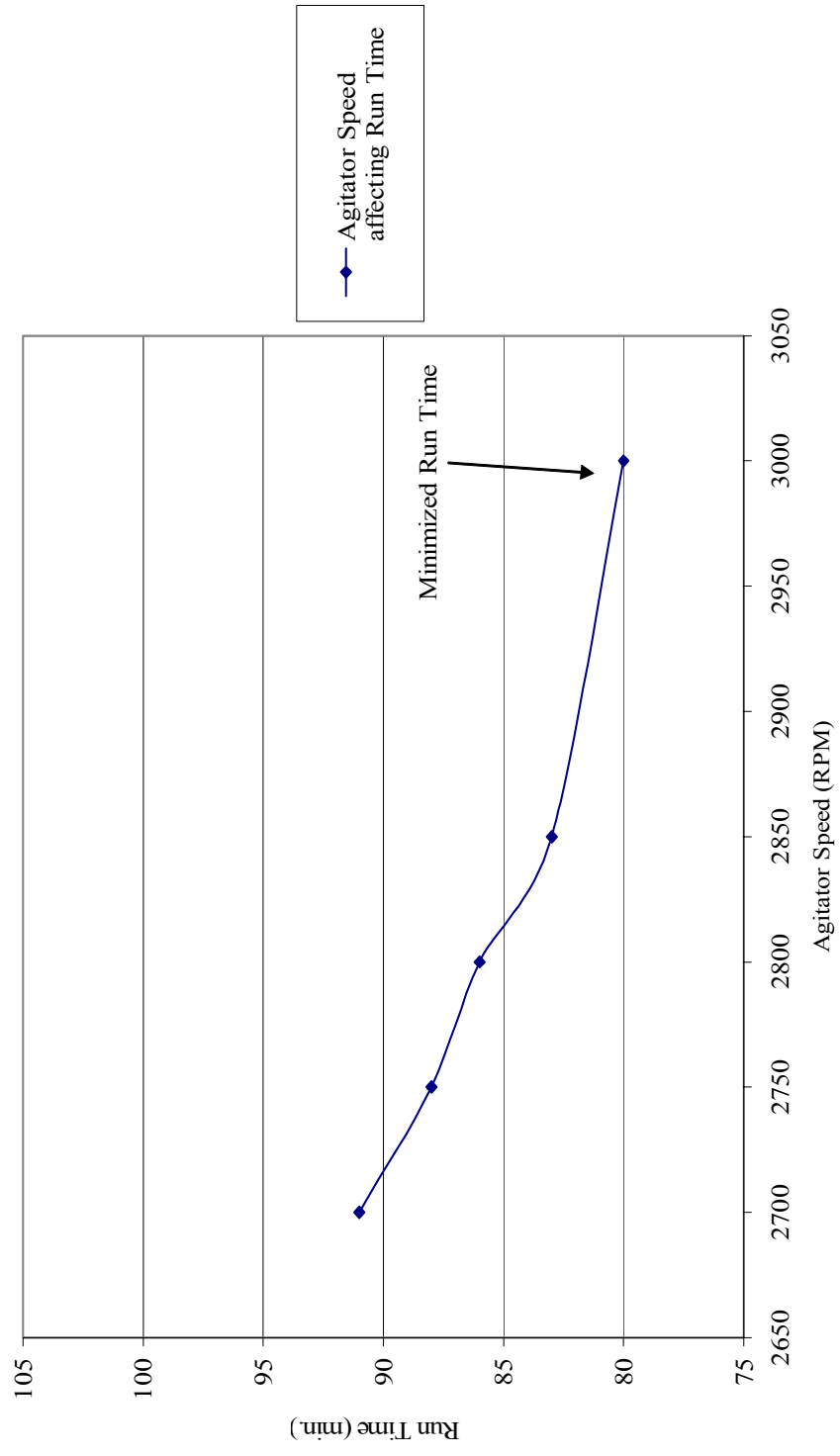

FIGURE 18 - Agitator Speed Effects on Processing Time

maximum speed) the time necessary to reach approximately 600 kW-hr/tonne of slurry increased. The product temperature and mill chamber pressure also stayed within working limits. FIGURE 18 establishes that the greater the agitator speed, the smaller the run time. Because 3000 RPM is the max setting on the equipment, this value is regarded as a “best result”.

During runs 26 – 28, the pump speed was decreased in order to verify if the recirculation time would increase as expected. FIGURE 19 illustrates the affect of pump speed on particle size. Once the pump speed dropped below about 196 RPM, the decreased recirculation rate resulted in final material that did not meet the particle size specification of 99.9% less than 0.5 microns. Some of the material did not get sufficient time in the mill because the recirculation rate was too slow causing a coarser particle size distribution resulting in off spec material. As a pump speed of 196 RPM is close to the maximum speed of approximately 200 RPM, the maximum speed was chosen as a “best value”.

The operating parameter results predicted using Minitab statistical analysis were indeed close to the experimentally predicted results. Figure 20 illustrates the relative difference between the two results. Table VII lists the statistically predicted operating parameters and experimentally predicted operating parameters. The experimental values resulted in a run time of 80 minutes.

TABLE VII – STATISTICAL/EXPERIMENTAL RESULTS

Parameter	Statistical Analysis	Experimental
Shot Loading Level (%)	90	85
Agitator Speed (RPM)	3000	3000
Pump Speed (RPM)	200	200
Run Time (min)	87	80

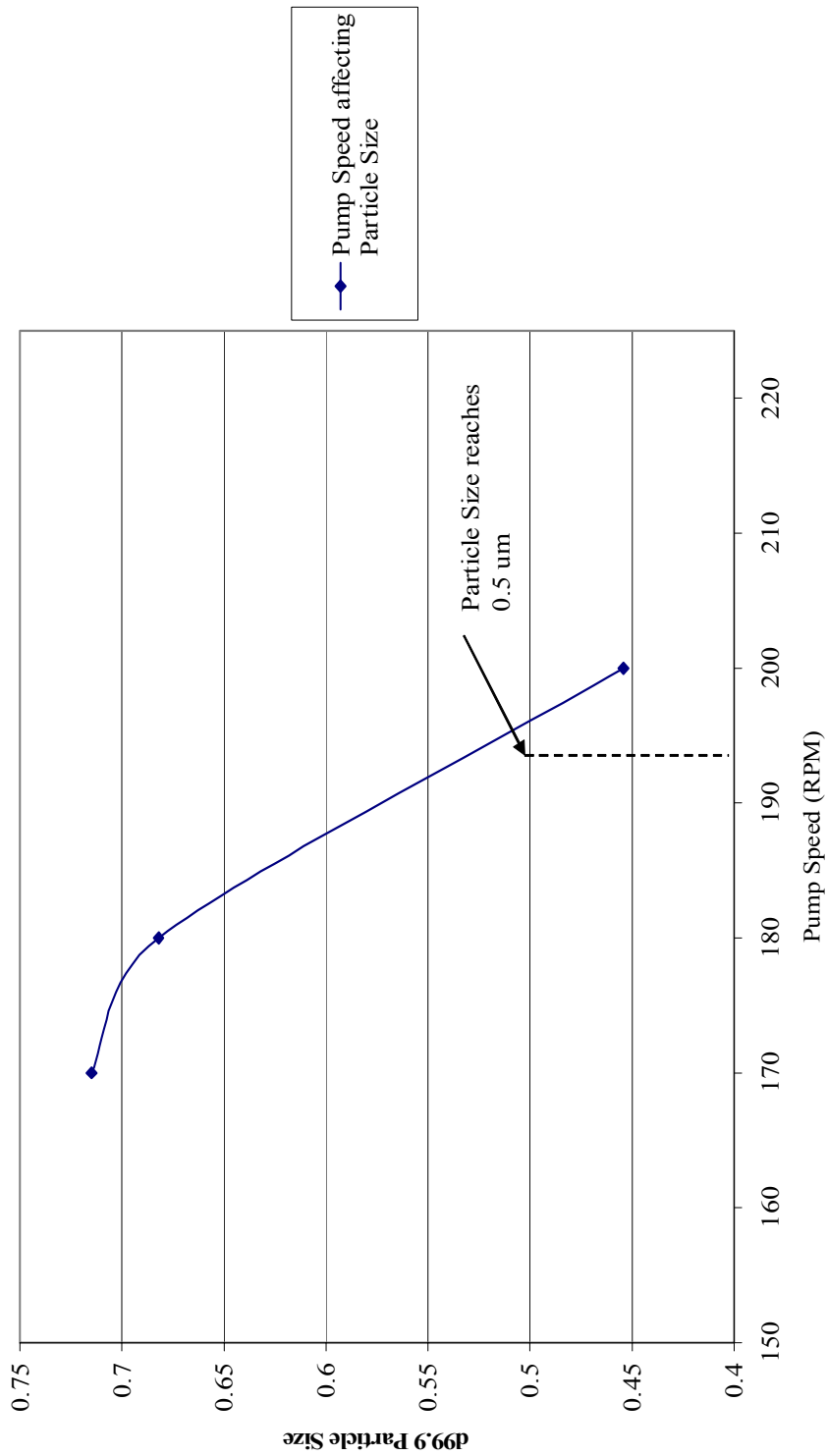

FIGURE 19 - Pump Speed Effects on Particle Size

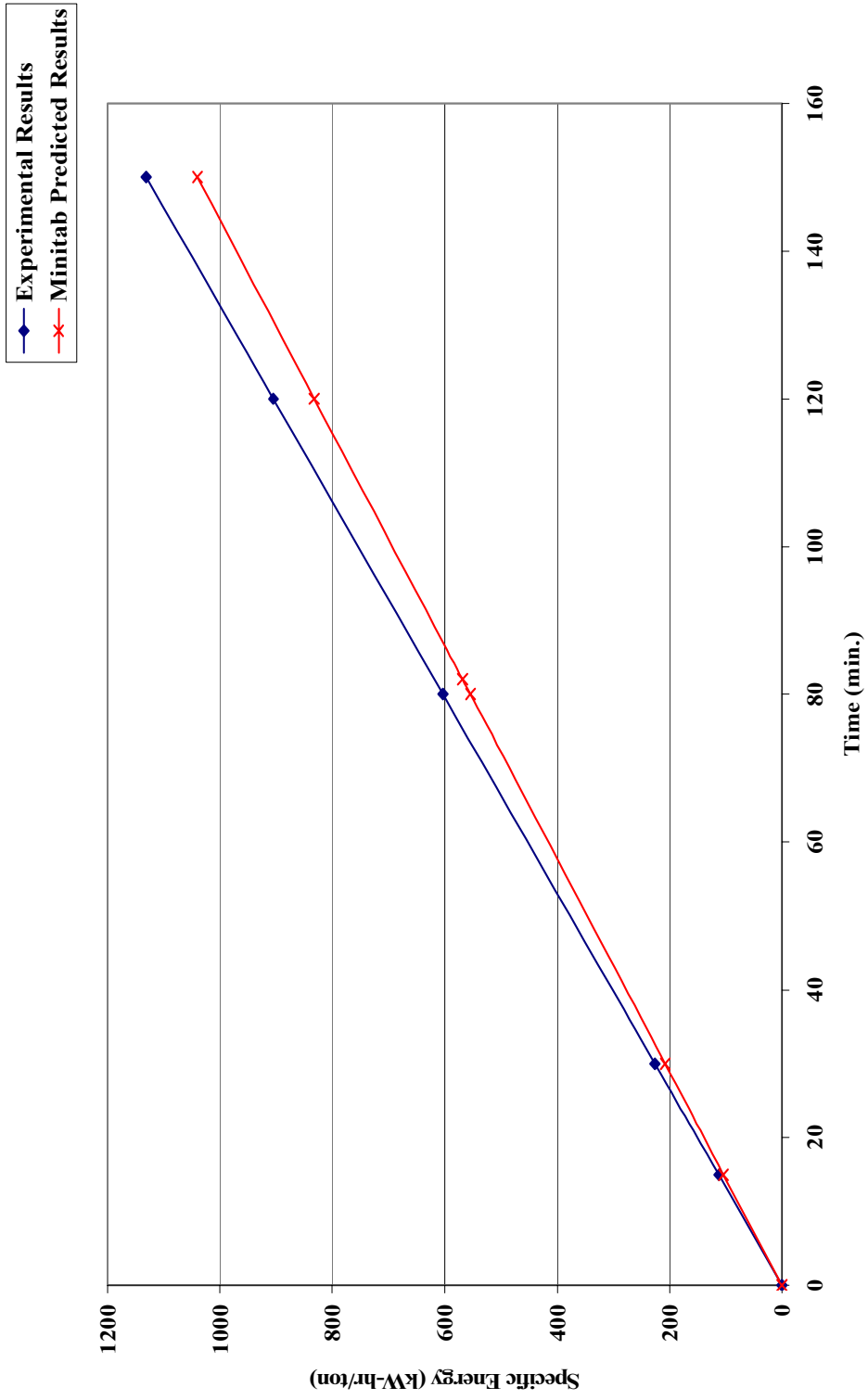

Figure 20 – Experimental Results Compared to Minitab Predictions

D. **Epilog**

The foregoing experiments were performed on a 550 cc laboratory apparatus – LMZ Zeta mill. The goal was to develop reasonable operating process conditions for successful operation of a larger (25L) industrial LMZ Zeta mill. On the larger unit, only small adjustments had to be made from these recommendations. Considerable time and expense were saved in starting up this unit and bringing it on line for continuous production.

V. CONCLUSIONS

- The specific energy required for a specific media mill to grind aqueous slurries of Pc at 44% solids using steel shot is about 600 kW-hr/ton of slurry to attain a d99.9 less than 0.5 microns.
- Preliminary experiments indicate grind times of about 100 minutes to achieve a d99.9 less than 0.5 microns.
- Shot loading level was the most important operating parameter.
- Optimization experiments revealed the optimal conditions for the three independent factors are: pump speed = 200 RPM, agitator speed = 3000 RPM, shot loading = 90% resulting in a run time of about 85 minutes.
- Validation experiments identify that pump speed of 200 RPM, agitator speed of 3000 RPM, and shot loading of 85% result in a minimized run time of about 80 minutes.

VI. RECOMMENDATIONS

- Further testing should be completed on percent solids in order to determine whether or not the customer specified 44% is actually the optimized value.
- Further testing should also be performed on the exact media size relationship to the time necessary to reach the desired particle size of d99.9 less than 0.5 microns.
- Further testing should also be performed on the proportionality constant in the energy transfer theory.
- Further work performed with computational fluid dynamics.

REFERENCES

- Bond, F.C. "The Third Theory of Comminution." Mining Engineering (May 1952): 484-494.
- Coatings and Inks. "Grinding Stage." Nov 2005.
<<http://www.specialchem4coatings.com/tc/dispersion/index.aspx?id=grinding>>
- Engel, Michael K., Kawamura Rikagaku, and Kenkyusho Hokoku. "Single-Crystal and Solid-State Molecular Structures of Phthalocyanine complexes." Chem. Abstracts. Vol. 127 (1998): 11-54
- Fogler, H. Scott. Elements of Chemical Reaction Engineering. 3rd Ed. New Jersey: Prentice Hall, 1999.
- Friedrich, Albin J. "Size Reduction Overview: Shear, Compression, and Impact." Powder and Bulk Engineering. Vol. 15.6 (2001)
- Hao, Zhimin, and Iqbal, Abul. "Some Aspects of Organic Pigments." Chemical Society Reviews. Vol. 26 (1997): 203 – 213.
- Horiba. Dynamic Light Scattering Nano Particle Size Analyzer. 2006. June 2006.
<<http://www.horiba-particle.com/lb-500/index.htm>>
- Indco Mixing Equipment. "Indco Catalog." July 2005 Issue.
- Kolb, G, and Ott, K. "Efficient Agitator Bead Mills." European Coatings Journal. Vol. 4 (1992): 212-215.
- Kunjappu, Joy. Essays in Ink Chemistry. New York: Nova Science, 2001.
- Laden, Pat. Chemistry and Technology of Water-Based Inks. New York: Chapman and Hall, 1997.
- McCabe, Warren L., Julian C. Smith, and Peter Harriott. Unit Operations of Chemical Engineering. New York: McGraw-Hill Companies, Inc., 2001
- McKeown, Neil. Chemistry of Solids State Materials, No 6. New York: Reinhold, 1963.
- McKeown, Neil B. "Out of the Blue: Recent Advances in the Applications of Phthalocyanines." Chemistry and Industry. (1999): 92-98

- McKeown, Neil B. Phthalocyanine Materials : Synthesis, Structure and Function (Chemistry of Solid State Materials). Cambridge University Press, 1998
- McLaughlin, John R. “Bead Size and Mill Efficiency.” Ceramic Industry. (Dec. 1999): 34
- Morgan, M.N., W.B. Rowe, and A. Batako. “Energy Limitations in HEDG and Conventional Grinding.” Trans Tech Publication, Switzerland. Material Vols. 257-258 (2004): 63 – 68.
- Myers, Drew. Surfactant Science and Technology. New York: VCH, 1992.
- Netzsch Incorporated. Advanced Designs for Fine Grinding. 2006
<http://www.netzsch-feinmahltechnik.de/technologie/e-nass_zeta.html>
- Oldshue, James. Fluid Mixing Technology. New York: McGraw-Hill Pub. Co., 1983.
- Perry, Robert H., and Green, Donald W. Perry’s Chemical Engineers’: Platinum Edition. New York: McGraw-Hill Pub. Co., 1999.
- “Phthalocyanine.” Wikipedia Online. 2005. Wikipedia. 18 Nov. 2005.
<<http://en.wikipedia.org/wiki/Phthalocyanine>>.
- Roelofsen, D.P. “Developments in Dispersing Technology.” European Coatings Journal. Vol. 3 (1991): 128-144
- Savastano, David. “The Milling Report.” Ink World Feb. 2004: 36+
- Sterbacek, Z., and Tausk, P. Mixing in the Chemical Industry. Oxford: Pergamon Press, 1965.
- Weyershausen, Bernd, and Lehmann, Kathrin. “Industrial application of ionic liquids as performance additives.” Green Chem. Vol. 7 (2005): 15–19.
- Wikipedia. Phthalocyanine. Aug. 2005. Jan. 2006.
<<http://en.wikipedia.org/wiki/Phthalocyanine>>.

APPENDIX I
(SAMPLE CALCULATIONS)

Sample Calculations

(Experimental Specific Energy)

Power Consumption = 1.94 kW

No Load Power Consumption = 0.42 kW

Net Power Consumption = 1.94 – 0.42 = 1.52 kW

Batch Size = 4.20 kg

Recirculation Time₂ = 80 min.

Recirculation Time₁ = 30 min.

Specific Energy (at Recirculation Time₁) = 226 $\frac{\text{kW} - \text{hr}}{\text{tonne}}$

Specific Energy =

$$\frac{\text{net power consumption}}{\text{batch size} * (\text{recirculation time}_2 - \text{recirculation time}_1)} + \text{Specific Energy}_1$$

$$= \frac{1.52 \text{ kW}}{(4.20 \text{ kg}) \left(\frac{1}{80 \text{ min} - 30 \text{ min}} \right) \left(\frac{\text{tonne}}{1000 \text{ kg}} \right) \left(\frac{60 \text{ min}}{\text{hr}} \right)} + 226 \frac{\text{kW} - \text{hr}}{\text{tonne}} = 603 \frac{\text{kW} - \text{hr}}{\text{tonne}}$$

Or $603 \frac{\text{kW} - \text{hr}}{\text{tonne}} * 0.44\% \text{ solids} = 265 \frac{\text{kW} - \text{hr}}{\text{tonne}}$ of solids

Batch Size = 4.20 kg

Or $\left(603 \frac{\text{kW} - \text{hr}}{\text{tonne}} \right) (4.20 \text{ kg}) \left(\frac{\text{tonne}}{1000 \text{ kg}} \right) = 2.53 \text{ kW} - \text{hr}$

Sample Calculations

(Theoretical Specific Energy using Bond's Equation)

$$W = 10 * W_i \left(\frac{1}{P^2} - \frac{1}{F^2} \right)$$

$$W_i = 21 \frac{\text{kW} - \text{hr}}{\text{tonne}} \longrightarrow \text{(Pc is a "very hard" pigment, Table I)}$$

P = d80 of desired size = 0.22 μm (from FIGURE 13)

F = d80 of feed size = 1.3 μm (from FIGURE 13)

$$W = 10 \left(21 \frac{\text{kW} - \text{hr}}{\text{tonne}} \right) \left(\frac{1}{\sqrt{0.22\mu\text{m}}} - \frac{1}{\sqrt{1.3\mu\text{m}}} \right) = 264 \frac{\text{kW} - \text{hr}}{\text{tonne}} \text{ of solids}$$

$$W = 264 \frac{\text{kW} - \text{hr}}{\text{tonne}_{\text{solids}}} * \left(\frac{1}{44\% \text{ solids}} \right) = 599 \frac{\text{kW} - \text{hr}}{\text{tonne}_{\text{slurry}}}$$

Sample Calculations

(Theoretical Specific Energy using Energy Transferred Theory)

$$d_m = 0.25 \text{ mm (diameter of media)}$$

$$\rho_m = 7.75 \frac{\text{kg}}{\text{dm}^3} \text{ (density of media)}$$

$$d_s = 77.0 \text{ mm (shaft diameter)}$$

$$n = 2760 \text{ min}^{-1} \text{ (# of agitator revolutions)}$$

$$v_t = (2760 \text{ min}^{-1}) (77.0 \text{ mm}) \left(\frac{\text{m}}{1000 \text{ mm}} \right) \left(\frac{\text{min}}{60 \text{ s}} \right) (3.14) = 11.1 \frac{\text{m}}{\text{s}} \text{ (circumferential agitator speed)}$$

$$t = 80 \text{ min (residence time)}$$

$$BI_m = d_m^3 * \rho_m * v_t^2$$

$$BZ_m = n * t * \left(\frac{x}{d_m} \right)^2$$

$$E_{SP} = \kappa * BI_m * BZ_m$$

$$BI_m = (0.25 \text{ mm})^3 \left(7.75 \frac{\text{kg}}{\text{dm}^3} \right) \left(11.1 \frac{\text{m}}{\text{s}} \right)^2 \left(\frac{0.01 \text{ dm}}{\text{mm}} \right)^3 \left(\frac{\text{kW} - \text{hr}}{3,600,000 \text{ J}} \right) = 4.14 \times 10^{-12} \text{ kW} - \text{hr}$$

$$BZ_m = (2760 \text{ min}^{-1}) \left(\frac{60 \text{ min}}{\text{hr}} \right) (80 \text{ min}) \left(\frac{0.5 \text{ } \mu\text{m}}{0.25 \text{ mm}} \right)^2 \left(\frac{0.001 \text{ mm}}{\mu\text{m}} \right)^2 \left(\frac{\text{hr}}{60 \text{ min}} \right) = 0.8832$$

$$E_{SP} = \kappa (4.14 \times 10^{-12} \text{ kW} - \text{hr}) (0.8832) = 3.65 \times 10^{-12} \kappa \text{ kW} - \text{hr} / \text{piece of media}$$

$$V_{\text{tank}} = 0.55 \text{ L}$$

$$\text{Media charge} = 85\%$$

$$V_{\text{total media}} = 0.85 * 0.551 \text{ L} = 0.4675 \text{ L}$$

$$V_{\text{each media}} = \left(\frac{4}{3}\right)(3.14)\left(\frac{0.25 \text{ mm}}{2}\right)^3\left(\frac{0.1 \text{ cm}}{\text{mm}}\right)^3\left(\frac{0.001 \text{ L}}{\text{cm}^3}\right) = 8.18 \times 10^{-9} \text{ L}$$

$$\# \text{ of media} = \frac{0.4675 \text{ L}}{8.18 \times 10^{-9} \text{ L}} = 57,142,991$$

$$E_{\text{SP}} = \kappa \left(3.65 \times 10^{-12} \frac{\text{kW} - \text{hr}}{\text{piece of media}} \right) (57,142,991 \text{ pieces of media}) = \kappa * 2.09 \times 10^{-4} \text{ kW} - \text{hr}$$

Batch Size = 4.20 kg

$$E_{\text{SP}} = \kappa (2.09 \times 10^{-4} \text{ kW} - \text{hr}) \left(\frac{1}{4.20 \text{ kg}} \right) \left(\frac{1000 \text{ kg}}{\text{tonne}_{\text{slurry}}} \right) = \kappa * 4.98 \times 10^{-2} \frac{\text{kW} - \text{hr}}{\text{tonne}_{\text{slurry}}}$$

APPENDIX II
(PRELIMINARY DATA)

APPENDIX II

TABLE VIII - PRELIMINARY DATA

Mill Volume {minus shaft volume usage} (l)	0.55							
Shaft Diameter (mm)	77.0							
Mill Void Volume {after media charge} (l)	0.29							
Motor Hp	3							
No Load Power Consumption (kW)	0.42							
Shot Size (mm)	0.25							
Media Volume Charge	80%							
Void Volume between Media	40%							
	Run # 1							
Sample Number	1	2	3	4	5	6	7	8
Kilograms Pigment	1.68	1.68	1.68	1.68	1.68	1.68	1.68	1.68
Percent Solids	44%	44%	44%	44%	44%	44%	44%	44%
Specific Gravity	1.12	1.12	1.12	1.12	1.12	1.12	1.12	1.12
Batch Size (kg)	4.20	4.20	4.20	4.20	4.20	4.20	4.20	4.20
Batch Size (l)	3.75	3.75	3.75	3.75	3.75	3.75	3.75	3.75
Recirculation Time (min)	0	15	30	60	90	100	120	150
Chamber Pressure (bar)	N/A	0.6	0.7	0.6	0.5	0.5	0.5	0.5
Agitator Speed (RPM)	N/A	3000	3000	3000	3000	3000	3000	3000
Power Consumption (kW)	N/A	1.94	1.94	1.94	1.94	1.94	1.94	1.94
Net Power Consumption (kW)	N/A	1.52	1.52	1.52	1.52	1.52	1.52	1.52
Specific Energy (kW-hr/ton) of Slurry	N/A	90	181	362	543	603	724	905
Pump Speed (RPM)	N/A	200	200	200	200	200	200	200
Recirculation Rate (kg/min)	N/A	0.60	0.60	0.60	0.60	0.60	0.60	0.60
Residence Time (min)	N/A	1.1	2.3	4.6	6.9	7.6	9.2	11.4
Batch Turnovers	N/A	2	4	9	13	14	17	21
Outlet Temperature (°C)	N/A	57	54	55	55	54	55	55
Chill Water In Temperature (°C)	N/A	5	4	4	4	4	5	5
Chill Water Out Temperature (°C)	N/A	15	10	9	10	10	10	10
Chill Water Flow (l/min)	N/A	4	12	12	12	12	12	12
Viscosity (CP)	200	200	200	200	200	200	500	500
Particle Size: Mean	1.136	0.330	0.256	0.213	0.195	0.186	0.175	0.190
Particle Size: (d10)	0.621	0.176	0.152	0.146	0.134	0.130	0.120	0.115
Particle Size: (d50)	0.856	0.235	0.206	0.191	0.184	0.178	0.165	0.156
Particle Size: (d90)	1.476	0.562	0.327	0.286	0.268	0.253	0.242	0.234
Particle Size: (d97)	3.258	1.295	0.894	0.587	0.325	0.299	0.291	0.291
Particle Size: (d99.9)	4.023	2.357	2.016	0.985	0.521	0.448	0.450	0.458

TABLE VIII - PRELIMINARY DATA (cont.)

Run # 2								
Sample Number	9	10	11	12	13	14	15	16
Kilograms Pigment	1.68	1.68	1.68	1.68	1.68	1.68	1.68	1.68
Percent Solids	44%	44%	44%	44%	44%	44%	44%	44%
Specific Gravity	1.12	1.12	1.12	1.12	1.12	1.12	1.12	1.12
Batch Size (kg)	4.20	4.20	4.20	4.20	4.20	4.20	4.20	4.20
Batch Size (l)	3.75	3.75	3.75	3.75	3.75	3.75	3.75	3.75
Recirculation Time (min)	0	15	30	60	90	100	120	150
Chamber Pressure (bar)	N/A	0.6	0.5	0.6	0.5	0.5	0.6	0.6
Agitator Speed (RPM)	N/A	3000	3000	3000	3000	3000	3000	3000
Power Consumption (kW)	N/A	1.94	1.94	1.94	1.94	1.94	1.94	1.94
Net Power Consumption (kW)	N/A	1.52	1.52	1.52	1.52	1.52	1.52	1.52
Specific Energy (kW-hr/ton) of Slurry	N/A	90	181	362	543	603	724	905
Pump Speed (RPM)	N/A	200	200	200	200	200	200	200
Recirculation Rate (kg/min)	N/A	0.60	0.60	0.60	0.60	0.60	0.60	0.60
Residence Time (min)	N/A	1.1	2.3	4.6	6.9	7.6	9.2	11.4
Batch Turnovers	N/A	2	4	9	13	14	17	21
Outlet Temperature (°C)	N/A	55	55	56	56	55	56	55
Chill Water In Temperature (°C)	N/A	3	4	4	5	5	5	5
Chill Water Out Temperature (°C)	N/A	10	10	10	10	10	9	10
Chill Water Flow (l/min)	N/A	12	12	12	12	12	12	12
Viscosity (CPS)	200	200	200	200	200	200	500	500
Particle Size: Mean	1.098	0.290	0.275	0.221	0.200	0.184	0.174	0.195
Particle Size: (d10)	0.615	0.174	0.146	0.129	0.127	0.141	0.114	0.118
Particle Size: (d50)	0.862	0.236	0.216	0.187	0.174	0.169	0.159	0.156
Particle Size: (d90)	1.502	0.565	0.336	0.291	0.281	0.276	0.228	0.236
Particle Size: (d97)	3.142	1.298	0.856	0.574	0.305	0.320	0.294	0.298
Particle Size: (d99.9)	4.015	2.385	2.046	0.993	0.546	0.452	0.459	0.465

TABLE VIII - PRELIMINARY DATA (cont.)

Run # 3								
Sample Number	17	18	19	20	21	22	23	24
Kilograms Pigment	1.68	1.68	1.68	1.68	1.68	1.68	1.68	1.68
Percent Solids	44%	44%	44%	44%	44%	44%	44%	44%
Specific Gravity	1.12	1.12	1.12	1.12	1.12	1.12	1.12	1.12
Batch Size (kg)	4.20	4.20	4.20	4.20	4.20	4.20	4.20	4.20
Batch Size (l)	3.75	3.75	3.75	3.75	3.75	3.75	3.75	3.75
Recirculation Time (min)	0	15	30	60	90	100	120	150
Chamber Pressure (bar)	N/A	0.5	0.5	0.6	0.6	0.5	0.6	0.6
Agitator Speed (RPM)	N/A	3000	3000	3000	3000	3000	3000	3000
Power Consumption (kW)	N/A	1.94	1.94	1.94	1.94	1.94	1.94	1.94
Net Power Consumption (kW)	N/A	1.52	1.52	1.52	1.52	1.52	1.52	1.52
Specific Energy (kW-hr/ton) of Slurry	N/A	90	181	362	543	603	724	905
Pump Speed (RPM)	N/A	200	200	200	200	200	200	200
Recirculation Rate (kg/min)	N/A	0.60	0.60	0.60	0.60	0.60	0.60	0.60
Residence Time (min)	N/A	1.1	2.3	4.6	6.9	7.6	9.2	11.4
Batch Turnovers	N/A	2	4	9	13	14	17	21
Outlet Temperature (°C)	N/A	56	55	57	55	54	55	55
Chill Water In Temperature (°C)	N/A	3	5	5	5	5	5	5
Chill Water Out Temperature (°C)	N/A	9	9	10	10	10	10	10
Chill Water Flow (l/min)	N/A	12	12	12	12	12	12	12
Viscosity (CPS)	200	200	200	200	200	200	500	500
Particle Size: Mean	1.145	0.360	0.262	0.251	0.198	0.165	0.163	0.192
Particle Size: (d10)	0.598	0.184	0.156	0.134	0.131	0.129	0.129	0.120
Particle Size: (d50)	0.843	0.246	0.235	0.187	0.181	0.175	0.161	0.151
Particle Size: (d90)	1.512	0.576	0.315	0.291	0.286	0.274	0.218	0.225
Particle Size: (d97)	3.147	1.285	0.854	0.574	0.405	0.324	0.290	0.300
Particle Size: (d99.9)	4.008	2.396	2.106	0.984	0.534	0.456	0.452	0.463

APPENDIX III
(VALIDATION DATA)

APPENDIX III

TABLE IX - VALIDATION DATA

Mill Volume {minus shaft volume usage} (l)	0.55
Shaft Diameter (mm)	77.0
Motor Hp	3
Shot Size (mm)	0.25
Void Volume between Media	40%

Run Number	12	13	14	15	16
Media Volume Charge	0.95	0.93	0.91	0.89	0.87
Mill Void Volume {after media charge} (l)	0.2365	0.2431	0.2497	0.2563	0.2629
Kilograms Pigment	1.68	1.68	1.68	1.68	1.68
Percent Solids	44%	44%	44%	44%	44%
Specific Gravity	1.12	1.12	1.12	1.12	1.12
Batch Size (kg)	4.20	4.20	4.20	4.20	4.20
Batch Size (l)	3.75	3.75	3.75	3.75	3.75
Recirculation Time (min)	94	91	87	85	82
Chamber Pressure (bar)	0.6	0.7	0.5	0.5	0.5
Agitator Speed (RPM)	2700	2760	2850	2910	2980
No Load Power Consumption (kW)	0.99	0.92	0.82	0.75	0.68
Power Consumption (kW)	2.50	2.50	2.50	2.50	2.50
Net Power Consumption (kW)	1.51	1.58	1.68	1.75	1.82
Specific Energy (kW-hr/ton) of Slurry	609	608	606	608	602
Pump Speed (RPM)	200	200	200	200	200
Recirculation Rate (kg/min)	0.60	0.60	0.60	0.60	0.60
Residence Time (min)	5.9	5.9	5.8	5.8	5.7
Batch Turnovers	13	13	12	12	12
Throughput (kg/hr)	2.48	2.60	2.77	2.88	3.03
Outlet Temperature (°C)	67	65	65	60	58
Viscosity (CP)	200	200	200	200	200
Particle Size: (d99.9)	0.452	0.453	0.449	0.446	0.452

TABLE IX - VALIDATION DATA (cont.)

17	18	19	20	21	22	23	24	25
0.85	0.83	0.81	0.79	0.85	0.85	0.85	0.85	0.85
0.2695	0.2761	0.2827	0.2893	0.2695	0.2695	0.2695	0.2695	0.2695
1.68	1.68	1.68	1.68	1.68	1.68	1.68	1.68	1.68
44%	44%	44%	44%	44%	44%	44%	44%	44%
1.12	1.12	1.12	1.12	1.12	1.12	1.12	1.12	1.12
4.20	4.20	4.20	4.20	4.20	4.20	4.20	4.20	4.20
3.75	3.75	3.75	3.75	3.75	3.75	3.75	3.75	3.75
80	86	90	100	80	83	86	88	91
0.5	0.5	0.5	0.5	0.5	0.4	0.4	0.4	0.4
3000	3000	3000	3000	3000	2850	2800	2750	2700
0.60	0.52	0.49	0.41	0.60	0.60	0.60	0.60	0.60
2.50	2.23	2.09	1.79	2.50	2.41	2.32	2.25	2.19
1.90	1.71	1.60	1.38	1.90	1.81	1.72	1.65	1.59
603	606	607	609	603	607	608	606	611
200	200	200	200	200	200	200	200	200
0.60	0.60	0.60	0.60	0.60	0.60	0.60	0.60	0.60
5.7	6.3	6.8	7.7	5.7	6.0	6.2	6.3	6.5
11	12	13	14	11	12	12	13	13
3.15	2.82	2.64	2.26	3.15	2.98	2.83	2.72	2.60
55	54	55	55	55	55	54	54	54
200	200	200	200	200	200	200	200	195
0.451	0.448	0.447	0.451	0.445	0.478	0.469	0.452	0.651

TABLE IX - VALIDATION DATA (cont.)

26	27	28
0.85	0.85	0.85
0.2695	0.2695	0.2695
1.68	1.68	1.68
44%	44%	44%
1.12	1.12	1.12
4.20	4.20	4.20
3.75	3.75	3.75
80	80	80
0.5	0.4	0.4
3000	3000	3000
0.60	0.60	0.60
2.50	2.50	2.50
1.90	1.90	1.90
603	603	603
200	180	170
0.60	0.52	0.47
5.7	5.7	5.7
11	10	9
3.15	3.15	3.15
54	54	54
200	200	200
0.454	0.682	0.715

VITA

Robert Ian McDowell was born on October 29, 1981 to Robert and Melanie McDowell. He was born in Louisville, KY and will always be the biggest Louisville basketball and football fan.

Ian graduated from Elizabethtown High School in 2000 where he was a member of the varsity track team and various student club organizations. He followed in his father, mother, uncle, and two sister's footsteps, choosing an education at the University of Louisville. While attending UofL, Ian was an active member in intramural sports including: basketball; football; soccer; and volleyball. Ian graduated from the University of Louisville obtaining a BSChE in Chemical Engineering in December of 2005. He then pursued and graduated with his Master of Engineering in chemical engineering August of 2006.